

Department of Empowerment of Persons with Disabilities (Divyangjan)
Ministry of Social Justice & Empowerment



कोशल शलमुणव चाताप्रगति
NCVET



सत्यमेव जयते
GOVERNMENT OF INDIA
MINISTRY OF SKILL DEVELOPMENT
& ENTREPRENEURSHIP



REIMAGINE FUTURE
N.S.D.F.C



Participant Handbook

Sector

Apparel / Made-Up's and Home Furnishing

Sub-Sector

Apparel / Made-Up's / Home Furnishing

Occupation

Stitching



Reference ID: **AMH/Q0301, Version 2.0**

Reference ID: **PWD/AMH/Q0301, Version 2.0**

NSQF level: 3



Sewing Machine Operator

for Locomotor Disability

for Speech and Hearing Impairment

<https://youtu.be/aHo2Kp2LeiY>

Scan QR code to access e-book

All Rights Reserved.

Second Edition

ISBN: 978-93-86620-59-0

Printed in India

Copyright ©



Apparel Made-ups & Home Furnishing Sector Skill Council

Flat No. A-312 to A-323, 3rd Floor, Somdatt Chamber-1,

Bhikaji Cama Place, Africa Avenue, New Delhi-110066

E-mail: jdop@sscammh.com

Website: www.sscammh.com

Disclaimer

The information contained herein has been obtained from sources reliable to AMHSSC. AMHSSC disclaims all warranties to the accuracy, completeness or adequacy of such information. AMHSSC shall have no liability for errors, omissions, or inadequacies, in the information contained herein, or for interpretations thereof. Every effort has been made to trace the owners of the copyright material included in the book. The publishers would be grateful for any omissions brought to their notice for acknowledgements in future editions of the book. No entity in AMHSSC shall be responsible for any loss whatsoever, sustained by any person who relies on this material. The material in this publication is copyrighted by AMHSSC. No parts of this publication may be reproduced, stored or distributed in any form or by any means either on paper or electronic media, unless authorized by the AMHSSC.



Note: SCPwD

SCPwD has borrowed the qualification of Sewing Machine Operator from Apparel SSC which is approved by NCVET in the 18th meeting of

NSQC on 28th April 2022 (Link of MOM

https://nqr.gov.in/sites/default/files/Q%20file%20Retail%20Trainee%20Associate_LV.pdf And uploaded on NQR WWW.nqr.gov.in The

book caters to the job role aligned to the following disabilities as per the NQR codes mentioned below.

For LD- 2022/PWD/SCPWD/05827

For SHI- 2022/PWD/SCPWD/05828



Shri Narendra Modi
Prime Minister of India

“ Skilling is building a better India.
If we have to move India towards
development then Skill Development
should be our mission. ”



Certificate

COMPLIANCE TO QUALIFICATION PACK – NATIONAL OCCUPATIONAL STANDARDS

is hereby issued by the

Skill Council for Persons with Disability

for

SKILLING CONTENT: PARTICIPANT HANDBOOK

Complying to National Occupational Standards of

Job Role/ Qualification Pack: Sewing Machine Operator (Divyangjan)

QP. No. PWD/AMH/Q0301 NSQL LEVEL 3

Date of Issuance: January 27th, 2022

Valid up to*: January 27th, 2025

*Valid up to the next review date of the Qualification Pack or the
'Valid up to' date mentioned above (whichever is earlier)

Authorised Signatory
(Skill Council for Persons with Disability)

Acknowledgements

We are thankful to Methods Apparel Consultancy India Pvt Ltd and to all organisations and individuals who have helped us prepare this Participant Manual.

We are especially thankful to Shahi Exports Pvt Ltd, Orient Fashions Exports (India) Pvt Ltd, Matrix Clothing Pvt Ltd, Richa Global Exports Pvt Ltd, Modelama Exports Pvt Ltd, Numero Uno Clothing Ltd, FCR Kiran Modes and M/S Khorania Brothers for their kind support in the development of this manual.

About this book

This Participant Handbook is designed to enable training for the specific Qualification Pack(QP). Each National Occupational (NOS) is covered across Unit/s.

Key Learning Objectives for the specific NOS mark the beginning of the Unit/s for that NOS.

- AMH/N0102: Maintain work area, tools and machines
- AMH/N0103: Maintain health, safety and secure work place with Gender and PwD Sensitization
- AMH/N0104: Comply with industry, regulatory and organizational requirements and Greening of Job roles
- AMH/N0301: Carry out stitching activities using machine or by hand
- AMH/N0302: Contribute to achieve product quality in stitching operations

The symbols used in this book are described below:

Symbols Used



Key Learning
Outcomes



Steps



Time



Tips



Notes



Unit
Objectives



Exercise

Table of Content

S. No.	Modules and Units	Page No.
1.	Introduction and Orientation	1
	Unit 1.1 - Introduction to Sewing and Apparel Sector	3
	Unit 1.2 - Role and Responsibilities of Sewing Machine Operator	8
2.	Carry out Stitching Activities Using Machine or By Hand (AMH/N0301)	11
	Unit 2.1 - Prepare for Stitching Operations	13
	Unit 2.2 - Stitch Components to Produce Apparels	38
	Unit 2.3 - Stitching a Trouser	58
	Unit 2.4 - Stitching a Shirt	76
3.	Contribute to Achieve Product Quality In Stitching Operations (AMH/N0302)	105
	Unit 3.1 - Contribute to Achieve Product Quality in Stitching Operations	107
4.	Maintain Work-Area, Tools and Machines (AMH/N0102)	139
	Unit 4.1 - Maintain Work Area, Tools and Machines	141
5.	Maintaining Health, Safety and Security at Workplace with Gender and PwD Sensitization (AMH/N0103)	149
	Unit 5.1 - Maintaining Health, Safety and Security in Workplace	151
	Unit 5.2 - First Aid	167
	Unit 5.3 - Sensitivity towards People with disability and Gender Equality	178
6.	Comply with Industry, Regulatory and Organizational Requirements and Greening of Job Roles (AMH/N0104)	185
	Unit 6.1 - Comply with Industry, Regulatory and Organizational Requirements	187
7.	Professional Skills	197
	Unit 7.1 - Introduction to the Soft Skills	199
	Unit 7.2 - Effective Communication	201
	Unit 7.3 - Grooming and Hygiene	204
	Unit 7.4 - Development of Interpersonal Skill	206
	Unit 7.5 - Social Interaction	210
	Unit 7.6 - Group Interaction	212
	Unit 7.7 - Time Management	214
	Unit 7.8 - Resume Preparation	216
	Unit 7.9 - Interview Preparation	218
	Annexure - Resources	221







1. Introduction and Orientation

Unit 1.1 - Introduction to Sewing and Apparel Sector

Unit 1.2 - Role and Responsibilities of a Sewing Machine Operator



Key Learning Outcomes

At the end of this module, participants will be able to:

1. Familiarise with apparel industry.
2. Identify the role and responsibilities of sewing machine operator.

UNIT 1.1: Introduction to Sewing and Apparel Sector

Unit Objectives

At the end of this unit, participants will be able to:

1. Familiarise with apparel industry.
2. Describe the home furnishing and made-ups sub sectors.

1.1.1 Introduction to Sewing

Sewing is the craft of fastening or attaching objects using stitches made with a needle and thread. Sewing is the craft of using needle and thread to attach or fasten objects. It is one of the oldest existing crafts in the world.

Sewing was originally a handmade craft for many years. It was the invention of the sewing machine in the 1800s and the growth of technology and computerization in 1900s that increased the mass production of machine made objects. However, sewing by hand is still a globally popular practice. In areas like haute couture fashion, custom dress creation and such, fine hand sewing is an ongoing demand. Fine hand sewing is thus pursued by hobbyists and textile artists equally.

1.1.2 Apparel Sector – Industry Overview

The apparel and textile industry is one of the most booming industries. Apart from providing one of the basic necessities of life, it also plays an important role through its contribution to industrial output, employment generation, and the export earnings of the country. With Indian apparel and textile being among the world's largest producers, the country is also the 5th largest exporter of apparel and textile across the globe with US\$ 36.4 billion. (source: Annual T&A industry report 2021 by Wazir Advisors)

The textile industry is one of the oldest business options in India since the ancient age. Different types of textile fibers are produced in India, among which cotton, jute, silk, and wool are the major ones. Both skilled laborers and unskilled officials are needed to run this business smoothly. Thus, the textile and apparel industry serves as the platform offering a huge number of employment opportunities to eligible people in India. A brief on complete supply chain for apparel industry is shown as below.



Fig.1.1.1: The AMH Value Chain (Source: PwC Analysis 2021)

The apparel and textile industry contributes 5 percent to the country's GDP from the domestic sector, whereas 7 percent is contributed from the industrial output in value terms and the export earnings of the country acquire a contribution of 12 percent from the apparel and textile industry.

Exports of AMH products stood at US\$ 21.5 billion in the year 2019-20 and have grown at a CAGR of 3 per cent since 2009-10. Top exported Apparel and Home Textiles commodities include T-shirts, kitchen & toilet linen, bed linen, men's shirt, women's top. India's domestic AMH market is also expanding rapidly, and domestic consumption stood at US\$ 81 billion growing at a CAGR of 10 percent, between 2005-06 to 2018-19.

The Indian textile sub-sector has traditionally been contributing significantly to the economy and manpower as well as to the structural changes in the manufacturing sector. Several factors that would contribute to the growth would include:

- Rising income levels are expected to increase the demand for home textiles and garments from domestic Consumers.
- Free trade agreements provide India a comparative advantage in the export segment as compared to its competitors – China, Bangladesh and Pakistan – as they create opportunities for manufacturers to supply to potential markets in East Asia.
- Low production cost continues to be an advantage for the sector and, consequently, demand from existing foreign markets continues to increase.
- Structural changes in the sector, with a shift from vertically disintegrated to integrated large firms, with automated machines for yarn and fabric production.
- Increased spending on research and development to enter the specialized fabrics and technical textiles sector.
- Favorable policy environment to support domestic and foreign investments and the implementation of schemes to enhance the production capacity and improve technology.

Ready Made Garments

The ready-made garments segment comprises men's, women's and kid's clothing, which may be used for either private (home/office wear) or commercial (uniforms for school, waiters and flight crew) purposes. The ready-made garments section has grown rapidly in the last few years. Both exports and domestic demands shall drive sector growth in future.

- Men's wear is the biggest segment in the ready-made garment segment, comprising about 43 percent of its share in the total revenue generated. This is followed by women's wear, with a share of 38 percent; 10 percent share of boys wear and 9 percent for girls wear in the total revenue generated by the ready-made garment segment.
- Changing lifestyles and consumption patterns are expected to drive the sector's supply of casual wear with an 11 percent growth, which would drive demand for workforce with specialized skills in western formals design, blended fabrics and increased application work on clothes.

Departments in a Garment Factory

Pre-Production	Production	Auxiliary
<ul style="list-style-type: none"> • Marketing and business development • Design • Merchandising • Sampling • Production Planning and Control • Pattern Making • Fabric Store and fabric sourcing • Trims and Accessory Store • Fabric Testing Lab 	<ul style="list-style-type: none"> • Cutting department • Sewing department • Quality Control department • Machine Maintenance department • Garment Washing department • Finishing department • Printing department • Embroidery department • Packing 	<ul style="list-style-type: none"> • Industrial Engineering Department • EDP / IT department • Accounting Department • Human Resource and Administration • Shipping and documentation

Fig.1.1.2: Apparel production department

1.1.3 Made-ups and Home Furnishings

The made-ups sub-sector is growing at a steadily increasing pace in the country. The wide variety of products that come under this sub-sector are not only include necessities but also functional and luxury products. Made- ups sub-sector is divided into three (3) broad categories:

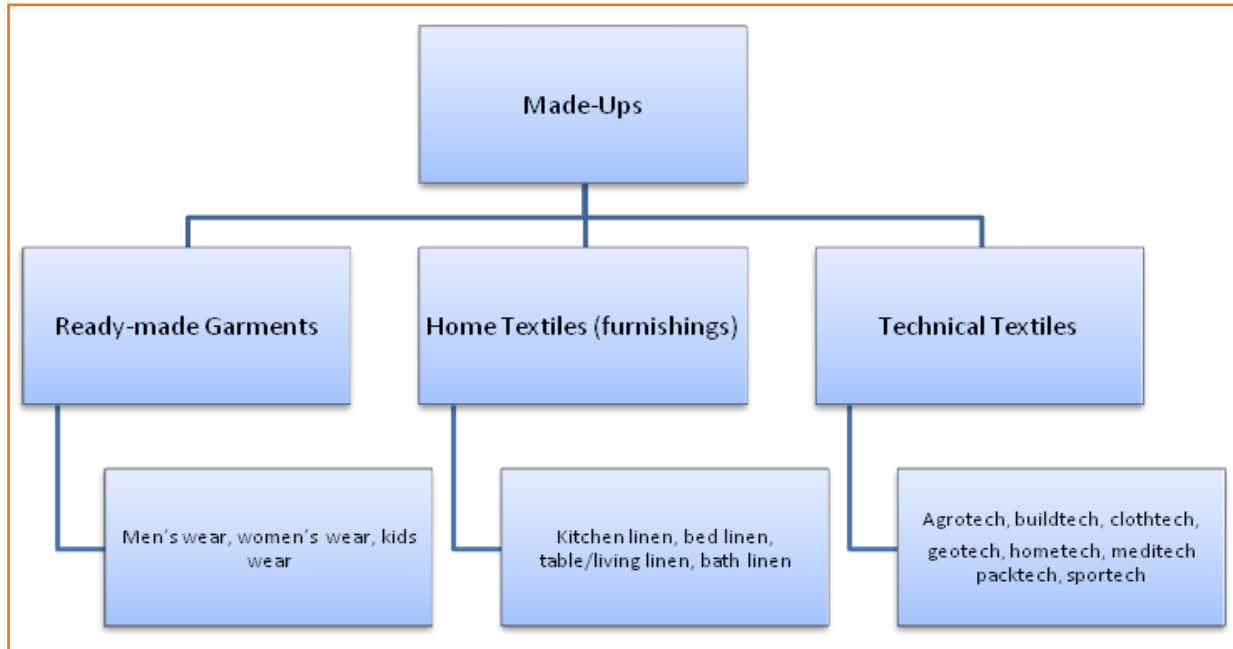

Fig.1.1.3: Made-ups and Home Furnishing Sub-sector

Indian is among one of the biggest exporters in Apparel and Made-ups industry. In Home Textiles India is second only to China in global exports, whereas in apparels, India is among the top 10. , India is fast becoming one of the leading global players in the Home Furnishings/ Textile. Home Furnishings industry offers wide varieties of products like bedspreads, furnishing fabrics, curtains, rugs, cushion covers etc.

The Indian Home Furnishing industry provides a unique blend of modern technology and ethnic techniques to bring out products that are one of the best in the world. The increase in the spending power of the Indian working class is also expected to contribute in the growth of domestic consumption of made-ups and home furnishings industry.



Fig.1.1.4: Home Furnishing

With increased demand and completion from countries like China, the demand of skilled workforce/kaarigars in the Home Furnishings industry is bound to increase in coming years

Size of Indian Textile and Apparel Industry

In India, the Apparel industry is spread across the country. However, the distribution of the clusters depends on the availability of raw material as well as the manufacturing. Cotton based units can be seen in all parts of the country, while the synthetic and woolen based industries are mainly concentrated in Maharashtra, Gujarat, Punjab, Jammu & Kashmir, Haryana, Madhya Pradesh and Uttar Pradesh. The silk-based industry finds concentration in Andhra Pradesh, Karnataka and Tamil Nadu while, jute clusters are largely located in Bihar and West Bengal.

Most of the apparel exporters (approx. 95%) are based out of Delhi NCR, Tamil Nadu Punjab, Rajasthan, Maharashtra and West Bengal. Rest of the India accounts for remaining 5% of the apparel exporters.

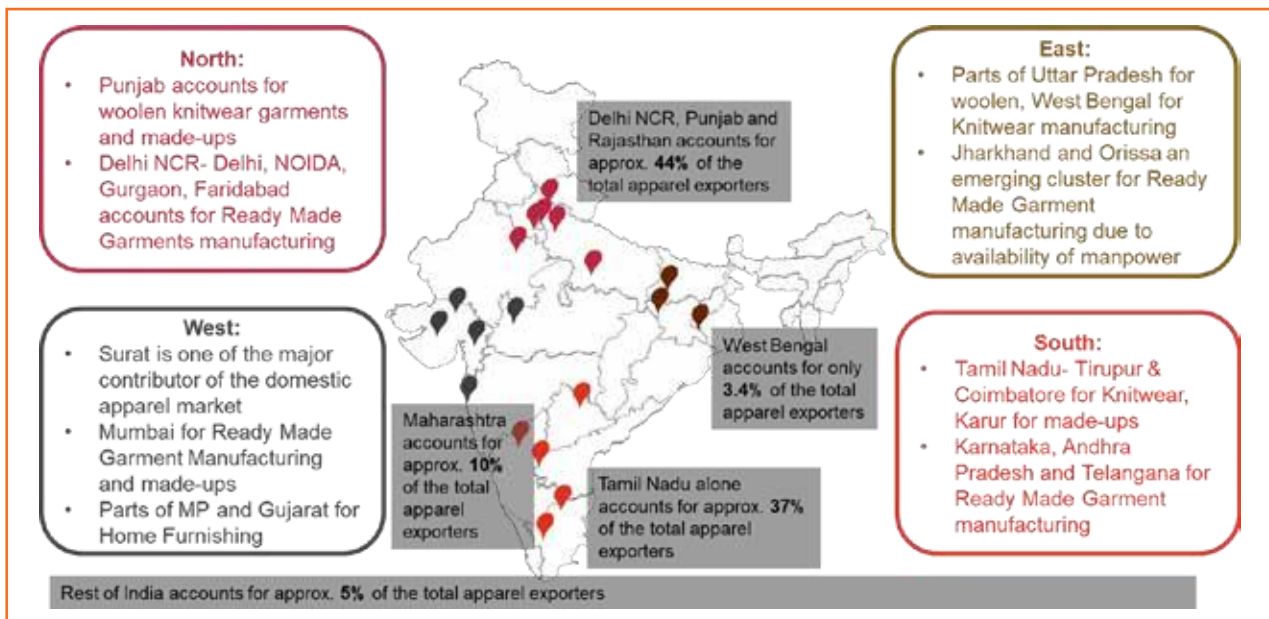

Fig.1.1.5: Major Apparel, Made-ups and Home Furnishing Clusters in India

1.1.4 Skill Development Policy

Indian government runs more than seventy skill development schemes at central, state and district level. The government has launched the Skill India flagship program to empower youth of the country by imparting employable skills to them. Under this initiative, the government has set up Ministry of Skill Development and Entrepreneurship (MSDE) to bring all the skill initiatives of the government under one umbrella and lead skill development ecosystem in the country. The ministry also launched a comprehensive Skill Development Policy in 2015 in which, detailed skill set requirement, courses offered, and roles and responsibilities of different stakeholders were defined. Further, sector wise skill gap analysis was also undertaken to understand sector specific skill requirement.

Pradhan Mantri Kaushal Vikas Yojana (PMKVY) and Deen Dayal Upadhyaya Grameen Kaushalya Yojana (DDU-GKY) are the flagship schemes which offer a variety of courses in the AMH sector. Among other skill development programmes, Integrated Skill Development Scheme (ISDS) was the main program run by the Ministry of Textiles, Government of India, introduced in XIIth Five Year Plan (FY 12-17).

The scheme had a target to train 1.5 million people for the T&A industry. As continuation of the scheme, the ministry has launched Scheme for Capacity Building in Textile Sector (SCBTS) also known as SAMARTH in 2018 with a target to train 1 million people in the sector.

ISDS has helped the industry by supplying skilled workforce, which, in turn, has helped the manufacturers in improving productivity and quality. Overall, it has helped in reducing cost, wastage and improving competitiveness that resulted in better business performances.

1.1.5 Employment Scenario in the Sector

Indian Garment Industry is closely connected to the fashion industry and grows hand in hand. Apparel Made-up & Home furnishing (AMH) is one of the largest employments generating sector in India, constituting about 60 per cent share of the total Textile and Apparel (T&A) exports. The Indian textile sub-sector has traditionally been contributing significantly to the economy and manpower as well as to the structural changes in the manufacturing sector. As per the latest round of Periodic Labor Force Survey (2018-19), the total workforce in India is estimated to be about 479 million. The share of labor working in the manufacturing sector was around 12.2 per cent (about 59 Million). Direct employment in the AMH sector primarily comes under manufacturing and the service sectors. The AMH sector employs about 35.8 million labour out of which 47% are engaged directly through the core manufacturing and trade of AMH product and 53% are engaged indirectly through the ancillary sector activities.

India is among the very few countries which have presence across the entire supply chain, from natural and synthetic fibers right up to finished goods manufacturing. It has presence in organised mill sector as well as decentralised sectors like handloom, power loom, silk, etc.

Incremental human resource requirement in core AMH sector, including manufacturing and trade is estimated to be about 35 Lakh for upcoming five years period between 2021-22 and 2025-26. Of the total incremental human resource demand, 89 per cent demand is projected to be in manufacturing of AMH products and 11 per cent demand is projected to be in trade related activity. Incremental labour demand in ancillary sector is estimated to be about 52 Lakh. Thus, the total incremental labour demand in AMH sector is about 87 Lakh.

Total incremental supply at all skill level, during the 2021-25 period, is projected to be of 18.4 Lakh. With the incremental demand of 31 Lakh, the skill gap in AMH - manufacturing is projected to be of 12.6 Lakh.

UNIT 1.2: Role and Responsibilities of Sewing Machine Operator

Unit Objectives

At the end of this unit, participants will be able to:

1. Know who is SMO.
2. Understand the roles and responsibilities of SMO.

1.2.1 Sewing Machine Operator- Job Description

Sewing Machine Operations involves stitching of components of garments together using a sewing machine. The role of a sewing machine operator is very critical to the industry as it enhances the quality of the product.

A Sewing Machine Operator, also called a 'Stitcher or Machinist' is an important job-role associated with Apparel sector. The primary responsibility of a machinist is to stitch/ sew fabric, fur, or synthetic materials to produce apparels.



Fig.1.2.1: SMOs on the Job

Attributes: A Sewing Machine Operator is associated with the Apparel sector. His/her primary responsibility is to sew and/or stitch fabric, synthetic materials or fur to produce apparel. A Sewing Machine Operator should be visually and physically fit. This includes a strong hand-eye-leg coordination and eyesight that is perfect both in near, distance, color, peripheral vision, ability to change focus and depth perception.

1.2.1.1 Job Overview

Sewing machine operators operate and tend sewing machines in order to perform garment sewing operations. This includes joining, reinforcing and decorating garments or parts of garments. Sewing machine operators handle work on a large scale as they are required to operate and tend to industrial machineries. They mount attachments such as needles and pattern blades and adjust machines according to the specifications provided to them.

Sewing machine operators also adjust machine controls and regulate stitching speeds for every sewing project that they work on. It is important for sewing machine operators to possess in depth knowledge of sewing machinery and the garments industry. They also need to have sound hand-eye coordination and be able to cope with moderate physical effort.

1.2.1.2 Sewing Machine Operator Duties and Responsibilities



- It is important to strictly refer to the clients' orders and accordingly use the best suited material.
- Ascertain that all supplies (auxiliary and essential) and materials are ready at hand before beginning the assignment.

- The machine should be started at the beginning of the shift and test it for full functionality.
- Address any discrepancies or problems faced during the testing period.
- According to the sewing project, the machine functions should be adjusted and threads should be drawn through needles.
- Materials should be placed properly and aligned under the needles to sew them together firmly.
- It is crucial to replace needles and also rethread them for other projects in future or in case the needle needs more thread for the ongoing project.
- Any defects or faults in stitching should be avoided by closely observing the operations.
- Notify supervisors of any problems or discrepancies during the sewing process.
- It is important to make sure that the product created should conform to the design demands and merchandising instructions listed in the order for the assignment.
- All excess threads and materials should be neatly cut away from the final product.
- Perform general and preventative maintenance tasks on sewing machines to ensure their longevity.
- Examine finished garments for compliance and ensure that appropriate tags are sewed on them.
- Count number of garments stitched during a shift and record this information in company provided logs.

Resources



Scan the QR codes or click on the link to watch the related videos.

Descriptions	QR Codes
Apparel industry in India	 https://youtu.be/tN5oLGSjepQ
Role and Responsibilities of Sewing Machine Operator	 https://youtu.be/aHo2Kp2LeiY

Exercise

1. When was sewing machine invented?
 - a) 20th century
 - b) 19th century
 - c) 18th century
 - d) 17th century
2. Increasing size of Domestic market is not good for Industry.
 - a) TRUE
 - b) FALSE
3. Sewing machine operators also responsible for cleaning and maintaining hazard free environment.
 - a) TRUE
 - b) FALSE
4. A Sewing Machine Operator, is responsible for producing quality product confirming quality standards given by buyer.
 - a) TRUE
 - b) FALSE
5. _____ scheme is governed by Ministry of Textiles.
 - a) PMKVY
 - b) Samarth
 - c) NULM
 - d) DDUGKY
6. Cutting Department is a part of:
 - a) Pre Production
 - b) Production
 - c) Post Production
 - d) None of the above
7. Full Name of MSDE is:
 - a) Ministry of short distance education
 - b) Ministry of Skill education
 - c) Ministry of Skill development and entrepreneurship
 - d) None of the above
8. Any _____ in stitching should be avoided by closely observing the operations.
 - a) Communication
 - b) Defect or Fault
 - c) Machine Fault
 - d) None of the above
9. A Sewing Machine Operator, is responsible for producing quality product confirming quality standards given by buyer.
 - a) TRUE
 - b) FALSE

2. Carry out Stitching Activities Using Machine or By Hand



Unit 2.1 - Prepare for Stitching Operations

Unit 2.2 - Stitch Components to Produce Apparels

Unit 2.3 - Stitching a Trouser

Unit 2.4 - Stitching a Shirt



Key Learning Outcomes

At the end of this module, participants will be able to:

1. Recognize the different types of industrial sewing machines.
2. Familiarize with the feed mechanisms.
3. Determine the basic list of material and tools required for pattern and stitching.
4. Check the equipment is safe and set-up in readiness for use.
5. Recognize about the different types of threads and needles.
6. Adjust the machine, Clean, Check oil, Check machine setting for right stitching, right tension and tighten any loose part of machine.
7. Correct fabric grain line for the style being worked on.
8. Check that the materials to be used as per desired quality and defect free.
9. Ask questions to obtain more information.
10. Estimate the expected length of time for the process.
11. Perform a test sew run.
12. Know the different types of stitching and seam.
13. Stich a trouser and shirt.

UNIT 2.1: Prepare for Stitching Operations

Unit Objectives



At the end of this unit, participants will be able to:

1. Recognize the different types of industrial sewing machines.
2. Familiarize with the feed mechanisms.
3. Determine the basic list of material and tools required for pattern & stitching.
4. Check the equipment is safe and set-up in readiness for use.
5. Recognize about the different types of threads and needles.

2.1.1 Industrial Sewing Machine

The industrial sewing machine is a substantial duty form of a typical home sewing machine. It is used in the apparel and other industries related to it such as furnishings stitching. One of the most common uses for the industrial sewing machine is to make the mass production sewing of pockets into attires made out of heavy opus, like denim for blue jeans.



Fig.2.1.1: Sewing Machine

For sewing that involves heavy volumes, industrial sewing machine is a key requirement. These machines are designed to sew multiple layers of material tougher than cloth like canvas, leather, vinyl at the same time. It is important to learn to recognize these machines because some machines, although labeled as industrial, are for normal home sewing and cannot handle materials heavier than cloth. A standard, commercial sewing machine is not designed to handle heavy work and is too fragile. A proper industrial sewing machine is equipped with a large servo motor and a clutch.

Industrial and traditional sewing machines have several differences. Industrial sewing machines are made to last for a longer period of time. Since they have to carry out professional level work, they are made with extra durable motors and parts. Sewing machines meant for home-like capacity will have plastic and/or nylon gears whereas parts belonging to industrial level machines- like connecting rods, housings, gears and body are made of stronger material like metals, for example, aluminum and cast iron.

2.1.1.1 Types of Industrial Sewing Machines

Sewing machine based on bed type

In this types the fabric travels with respect to the bed while being sewn, and the frame of the machine is constructed for the mounting the machine. There are five types of horizontal beds namely:

1. **Flatbed:** This is the most common type of machine that resembles the traditional sewing machines. In this, the needle and the arm extend to the flat base of the sewing machine. This is used by workers to sew flat pieces of fabric together.
2. **Cylinder-bed:** A Cylinder bed is a sewing machine frame, which permits one to sew cylindrically shaped items such as Cuffs, Sleeves, Trouser legs etc. It is also used for Button sewing and bar tacking. It is also used for button tapestry and bar attaching. It is used broadly in knitted fabrics. Cylinder bed is of two types: Length and Perimeter.



Fig.2.1.2: Flatbed Sewing Machine



Fig.2.1.3: Cylinder-bed Sewing Machine

- » **Length Cylinder Bed:** With this bed type the cylindrical item is sewed on a line parallel to its cylinder length. As the cylindrical item is sewed, it travels onto the bed part of the machine and encompasses the bed.
- » **Perimeter Cylinder Bed:** The Cylinder item is sewed parallel to the circumference of the item. The perimeter of the item travels around the perimeter of the bed arm.

3. **Post-bed:** This machine has bobbins, feed dogs and/or looper in perpendicular column that upsurges above the flat vile of the machine. This column's height ranges from 10cm to 45cm. Things that make measure to the sewing area difficult, such as fastening emblems, glove making and boot making utilize the post-bed machine.



Fig.2.1.5: Raised-bed Sewing Machine

5. **Feed off the arm:** These machines have a cylindrical bed suited for sewing goods in the tubular form. The cylindrical bed is in the form of an arm used for sewing of tubular goods like closing of sleeves, side seams, legs etc.



Fig.2.1.4: Post-bed Sewing Machine

4. **Raised bed:** It enables the assemblage of pre-stitched parts and is for the fitting of the fixtures and other attachments. It is the elementary form for numerous specialized machineries.



Fig.2.1.6: Feed - off the Arm Sewing Machine

Types of sewing machines based on stitch

Lockstitch Machine

The SNL, Single Needle Lock Stitch device is the most widespread and multipurpose sewing machine in the industry. It yields dependable results, both in production and in sample rooms. The Lockstitch arranges detailed and a straight stitches on the top and the underneath of the fabric, the needle thread and the bobbin thread locks each other, each time the needle badges through the fabric.

Features:

- The lockstitch machine produces the tightest and the most secured stitch.
- It has same appearance on both sides.
- A complete garment can be sewn on a lockstitch machine.



Fig.2.1.7: Lockstitch Sewing Machine



Fig.2.1.8: Multineedle Sewing Machine

Multineedle Sewing Machine

It is a multi-needle, double chain, flatbed stitch machine with parallel looper movement machinery. It is used in attaching waistband, lap seaming and line tapes, and implanting elastics.

Overlock Machine

Overlock machine is for stitching, over the edge of more than one pieces of fabric to create a neat border that is not fray. An overlocker will cut off the messy, rough fabric endings as they stitch.

This machine is a high speed sewing machine. And is the quickest performing machine to date, giving a non-fraying finish to the material.



Fig.2.1.9: Overlock Machine



Fig.2.1.10: Flatlock Machine

Flatlock Machine

Flatlock machines are high speed specialized machines. This type of machine is extremely efficient. The stitch is made by two or more needle threads passing through the fabric, inter twisting on the lower-side and interlocking on the upper-side. These are mainly used for knits.

- It is high speed, and make seams stretchy, flat and smooth.
- Delivers extensibility to the seams with a low bulk that a person can wear comfortably against the skin.

Applications and Seam Appearances

(Coverstitch) Often called a flat lock or flat seam stitch is used primarily on knits and lingerie. These stitches are referred to as top and bottom cover stitches and are commonly used to cover both sides of the seam.



Fig.2.1.11: The Seam Appearances

Button Attach Machine

Clothes are held together by buttons, a button is one of the most basic elements of fashion. Button sewing work requires a machine, which provides flexibility (in terms of button design, fabric variation, thread thickness etc.) as well as a consistently good sewing performance.

- This machine sews on buttons at high speeds, with accuracy thus saving time and fatigue.
- It can be used for attaching neck wraps and labels as well.



Fig.2.1.12: Button Attach Machine

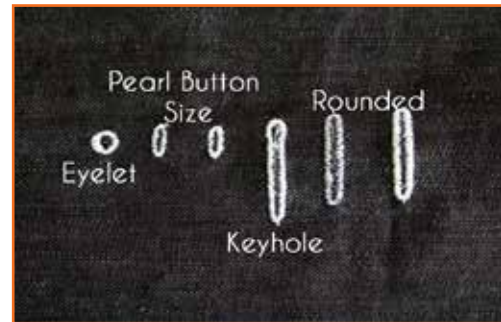

Fig.2.1.13: Different Types of Button Hole

2.1.2 Feed Mechanisms

Feed mechanisms are the basic movement of needles, loopers and bobbins. The material being stitched must move in order to facilitate, each cycle of needle movement includes a different part of the material. This movement is known as feed and sewing machines has many ways of feeding material as it does of forming stitches. Often, manifold types of feed are used on the same machine. The types of the feed mechanism are as follows:

1. Drop feed mechanism.
2. Differential bottom feed mechanism.
3. Adjust top feed mechanism.
4. Needle feed mechanism.
5. Unison feed mechanism.
6. Puller feed mechanism.

Drop Feed Mechanism

This humblest feed system of sewing machine is the most common. It is also called regular feed. Main apparatuses and gears of drop feed mechanism are:

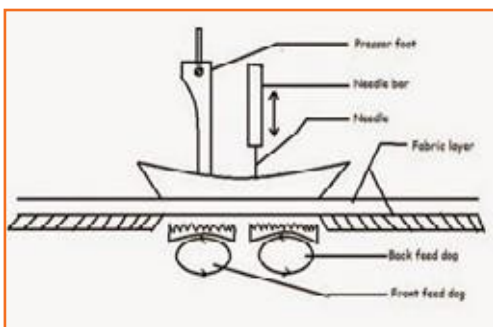

Fig.2.1.15: Differential Bottom Feed Mechanism

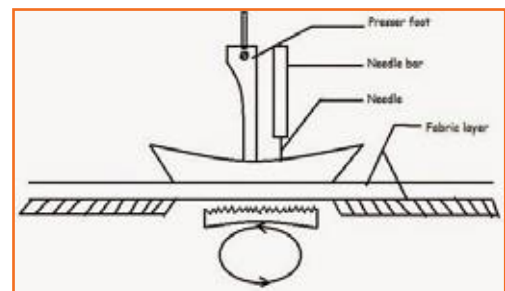

Fig.2.1.14: Drop Feed Mechanism

Differential Bottom Feed Mechanism

This mechanism is merely an amendment of the drop feed system. In the feed mechanism the feed dog consists of 2 segments. Appliance of each section of feed dog is like the drop feed system. But the speed of each part can be adjusted separately. Extensively used for stretchy materials.

When the speed of the front feed dog is higher than the back feed dog, the bottom strand is drawn by the back feed dog but this will overcome by the greater speed of the front feed dog. There is a lesser probability of shifting.

When the speed of the front feed dog is low, one can get lacy effect because the feeding speed is greater than the "Delivery speed". Widening and assembling of fabric can be done by this mechanism.

Adjustable Top Feed System

In a usual set-up, the presser foot is in two segment. One holding the fabric in position whereas the needle custom the stitch. The other taking length on the lower side & moving or wakening in a way that the top layer is taken along. The needle is out of the materials. In sewing machine, the feed mechanism can be used with both drop feed & differential bottom feed. Combination of adjustable feed & differential bottom feed can make top ply gathering or the gathering of bottom ply.

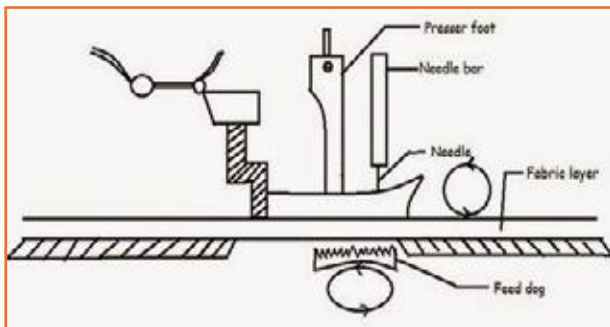

Fig.2.1.16 (a): Differential Bottom Feed Mechanism

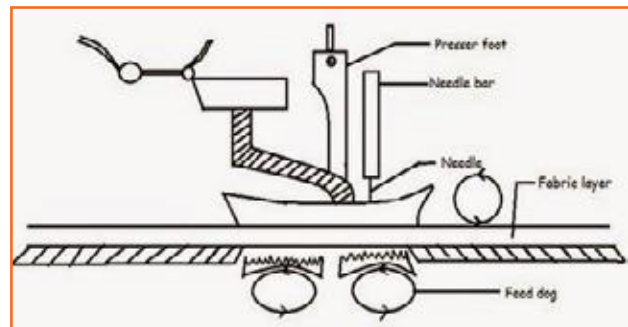

Fig.2.1.16 (b): Differential Bottom Feed Mechanism

Needle Feed System Mechanism

Needle Feed Mechanism is also known as Compound feed. Needle moves forwards & backward. Needle pierces the material enters into the notch of the feed dog. For the advance movement of one stitch span of fabric feed dog and needle pass the same distance at the same time. The needle rise up & moves to form the next stitch with one step advance. This is pragmatically useful in massive sewing situation like when quilting through the cloth or padding & for cuffing fabrics. For the change of stitch length, setting of both needle & feed dog should be changed.

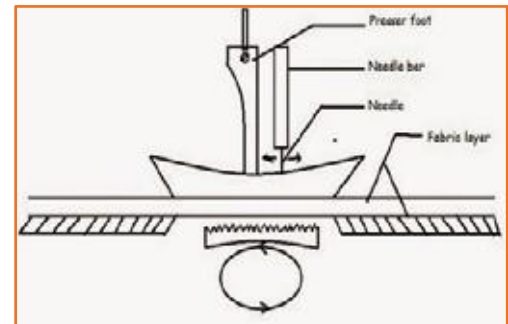

Fig.2.1.17: Needle Feed System Mechanism

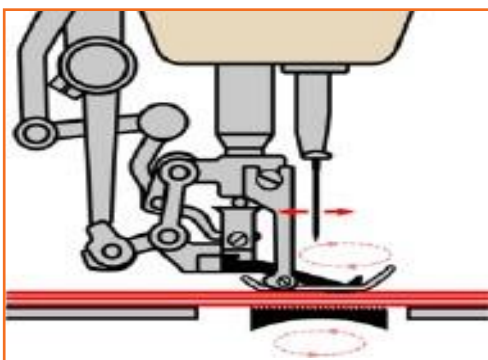

Fig.2.1.18: Unison Feed Mechanism

Unison Feed

Unison feed is a combination of feeding mechanisms and bottom feeding. It provides needle feed in addition to positive top.

Puller Feed Mechanism

This mechanism is variation of the drop feed system. These waves give a pulling movement on the fabric behind the presser foot. Top roller is driven by machine whitest the lower one moves due to control & presser of the top roller. The surface speed of puller roller is slightly higher than the feed dog speed to presser ply shifting roping.

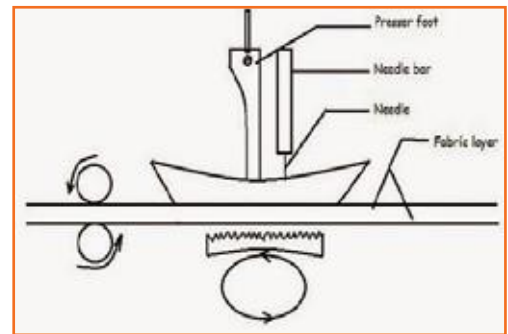

Fig.2.1.19: Puller Feed Mechanism

2.1.3 Parts of a Sewing Machine



Fig.2.1.20: Parts of a Sewing Machine

Needle: is one of the most important part of the machine, it carries thread through the fabric to the bobbin and completes stitch formation.



Fig.2.1.21: Needle



Fig.2.1.22: Hook

Hook: set is a devise in which bobbin and bobbin case can be fitted.

Bobbin Case: holds the bobbin and controls the thread tension.



Fig.2.1.23: Bobbin Case



Fig.2.1.24: Bobbin

Bobbin: holds the lower thread or the bobbin thread.

Throat plate: or needle plate forms a smooth surface over which fabric can move, it has a hole and sometimes also a markings to guide the seam allowance.



Fig.2.1.25: Throat Plate

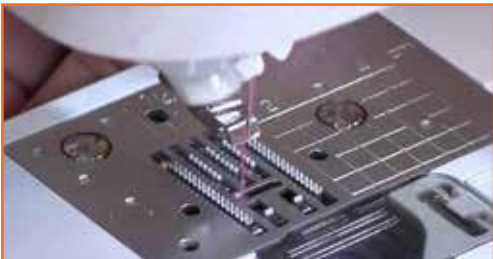

Fig.2.1.26: Feed Dog

Feed dog: moves the fabric through a predetermined distance.

Presser foot: holds the fabric firmly against throat plate, and teeth of the feed dog, it prevents the fabric from rising and falling with the needle.



Fig.2.1.27: Presser Foot



Fig.2.1.28: Reverse feed lever

Reverse feed lever: is used for backtack or back tacking.



Fig.2.1.29: Finger guard

Finger guard: is a safety device that prevents an operator's finger getting trapped or hurt by the needle.

Presser Bar: holds the presser foot.



Fig.2.1.30: Presser Bar



Fig.2.1.31: Tension post

Tension post: provides correct tension to the needle thread.

Presser foot regulator: is used to adjust the pressure depending on the type of the fabric.



Fig.2.1.32: Presser foot regulator



Fig.2.1.33: Thread take up lever

Thread take up lever: gives tension to the thread.

Oil sight window: indicates the presence of lubricating oil.



Fig.2.1.34: Oil sight window



Fig.2.1.35: Thread stand

Thread stand: used for supporting the thread package like spool bobbin etc.

Knee Lifter: is used to lift the presser foot with the use of knee.

Hand Lifter: is used to lift the presser foot.



Fig.2.1.36: Knee Lifter

Bobbin Winder: is used to wind thread in empty bobbin. It may be located differently in different types of machines.



Fig.2.1.37: Bobbin Winder



Fig.2.1.38: On-Off Switch

On-Off Switch: these are two switches, which are used to on and off the machines. The RED button is for switching the machine OFF and the BLACK/GREEN button is for switching the machine ON. Pedal: The machine does not start unless the pedal is depressed, it is majorly used for controlling the speed of the machine.

Attachments in Sewing Machines (Work Aids)

Attachments in Sewing Machine are devices which are built into machines. These are added to the sewing machine afterwards alongside and/or made use of, in whatever ways a resourceful engineer develop to increase productivity, maintain standards of quality, reduce training time and curtail tiredness for the operator.

Work Aids can be divided into the following categories:

Folders: Folders are used when fabric must be folded prior to sewing .They differ from the simple fold to extremely complex combinations of folders and indeed enable some to be achieved that would not be otherwise be possible at all. Folders are frequently used on machines having more than one needle.

Binder: Many binders are existing which add additional items of self-fabric or other material to a costume and of these, many come into the grouping are known as Binder. Fabric Edges are bound, either as a means of edge arranging or to create a embellished effect.



Fig.2.1.39: Binder



Fig.2.1.40: Hemmer

Hemmer: Folders which operate on a garment part without any additional material are knows as Hemmer.

Presser Foot and Presser feet: Presser Foot and Presser feet can be used as particular work aids, in addition to their normal function of holding the materials in contradiction of the feed dog, when the scale of the state is within the small size of foot. The function of edge guiding can be achieved in some circumstances by a special presser foot called recompensing presser foot.

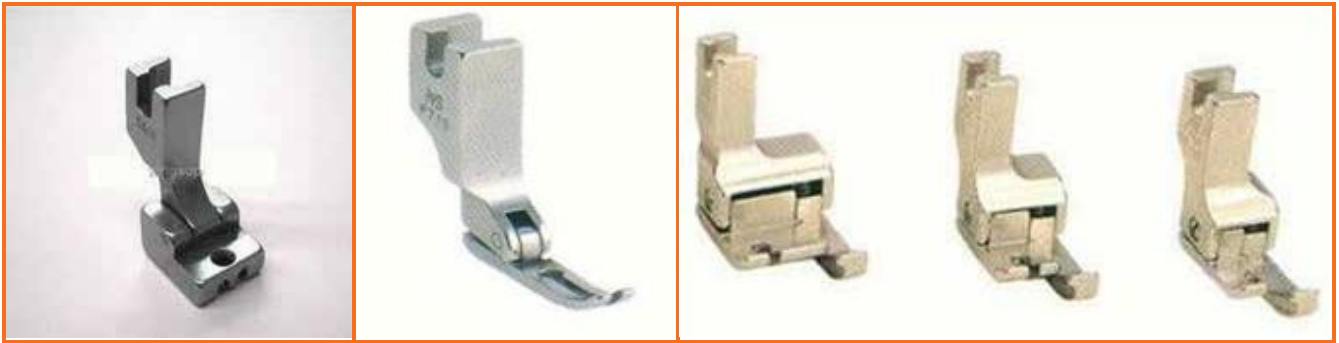

Fig.2.1.41: Presser Foot and Presser feet

Guides: Guides are used anywhere when sewing must take place in a certain spot on a garment. In their meekest form they are edge guides, forming some kind of physical fence to the edges of the fabric being joined together.



Fig.2.1.42: Guides

2.1.4 Basic List of Material and Tools Required for Stitching

Scissors: Scissor are utilized for cutting the fabric and has a handle which is aligned with the blade which helps you do the cutting steadily by keeping the scissors even.



Fig.2.1.43: Scissors



Fig.2.1.44: Rotary cutter

Rotary cutter: The rotary cutter is something which has a blade to cut easily and smoothly through fabric. It's very efficient to be used to all different kinds of projects, however it is especially good for quilting.

Thread: Various sort of threads are available, they are available in rainbow colors, including clear ones. For most of the sewing machines all you need is a need a spool of thread. The cone shaped threads are also used however they are for different kind of machine called a serger.



Fig.2.1.45: Threads



Fig.2.1.46: Measuring tape

Measuring tape: Measuring tape used for sewing to make it softer than that used for construction projects so that it can be used to fit clothing to the body.

Needles: A sewing machine requires diverse needles than which are used for hand-sewing. Machine needles have a bigger, blunter tip where they fit into the machine. Various types of needles are used on various kinds of projects.

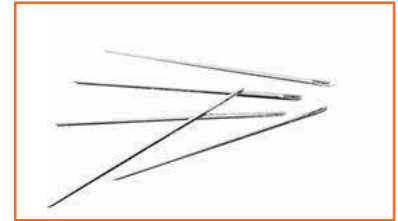

Fig.2.1.47: Needles



Fig.2.1.48: Fabric

Fabric: As different projects have different types of needle or thread requirements similarly as per the requirement different types of fabrics are also needed with different project for sewing.

Pins: Pins are used to hold fabric together where it's supposed to be sewn and to be adjusted as per the required fitting during alterations.

Pincushion: Pincushions are very useful in keeping the pins in order and in place, it is usually in apple's pumpkin's or tomato's shape.



Fig.2.1.49: Pins and Pincushion



Fig.2.1.50: Iron and Ironing Board

Iron and Ironing Board: An iron is used to press fabric, seams open and make darts. Your everyday iron is fine.

Seam ripper: The name says it all: It's used to rip seams. Especially comes in handy when you're a beginning sewer.



Fig.2.1.51: Seam ripper



Fig.2.1.52: Pinking Shears

Pinking Shears: Pinking shears cannot be used like normal scissors since they will lead to inaccurately cut lines of fabric. They are, however, crucial for finishing seams, hem edges etc.



Fig.2.1.53: Cutting Table

Cutting Table: A flat board placed on a table where the fabric is laid out and cut. The fabric can be pinned securely to the cutting board/table to prevent it from slipping.

Sewing Gauge: A 6 inch gauge with a movable indicator convenient for measuring short lengths.



Fig.2.1.54: Sewing Gauge

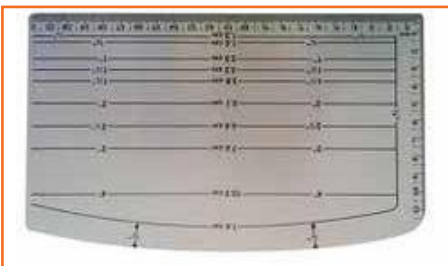

Fig.2.1.55: Hem Gauge

Hem Gauge: A measuring device marked with various depths and hemline folds. It is practical when hemming straight on grain edges.

Yardstick/Meter stick: Is use to measure fabric and to check grain line. It can be used in marking a long straight lines and in measuring hemlengths.



Fig.2.1.56: Yardstick/Meterstick



Fig.2.1.57: Hip Curve

Hip Curve: The Hip Curve is used in connecting or shaping slightly curve points. It has a measure of inches at the front and centimeters at the back part.

L-square: It is useful in constructing perpendicular lines with divisional parts located in longer and shorter arms.



Fig.2.1.58: L-square



Fig.2.1.59: Tailor's Chalk

Tailor's Chalk: A thin piece of hard chalk used in tailoring for making temporary alteration marks on clothing.

Novelty Yarns: Novelty yarns include a wide variety of yarns made with unusual features, structure or fiber composition such as slubs, inclusions, metallic or synthetic fibers, laddering and varying thickness introduced during production.



Fig.2.1.61: Masking Tape

French Curve: A French curve is a template usually made from metal, wood or plastic composed of many different curves. It is used in manual drafting to draw smooth curves of varying radii. The shapes are segments of the Euler spiral or clothoid curve.



Fig.2.1.63: Hand Needle

Punch Needle: A Punch needle is an easy to use tool that opens up a delightful world of dimensional needle art. It quickly and easily produces one-level or exciting three dimensional designs.



Fig.2.1.65: Frame, Round



Fig.2.1.60: Novelty Yarns

Masking tape: Also known as sticky tape, is a type of pressure-sensitive tape made of a thin and easy-to-tear paper, and an easily released pressure-sensitive adhesive. It is available in a variety of widths. It is used mainly in painting, to mask off areas that should not be painted.



Fig.2.1.62: French Curve

Hand Needle: Hand sewing needles are available in varying sizes with varying points. They guide the thread through fabric when you are hand sewing.



Fig.2.1.64: Punch Needle

Frame, round: Used for creating designs through hand stitch.

Pattern making paper: Used for practising cutting and creating patterns.



Fig.2.1.67: Tracing paper



Fig.2.1.66: Pattern making paper

Tracing paper: Tracing paper is paper made to have low opacity used for creating designs.

Hand held thread trimmer: Used for thread trimming.



Fig.2.1.69: Bent neck, metallic Tweezer



Fig.2.1.68: Hand held thread trimmer

Bent neck, metallic Tweezer: Tweezers are small tools used for picking up objects too small to be easily handled with the human hands

Pencils (HB, 2B, 4B): The graphite grading scales used to measure the hardness of a pencil's graphite core. The higher the number the harder the writing core and the lighter the mark left on the paper.



Fig.2.1.71: Pick glass



Fig.2.1.70: Pencils (HB, 2B, 4B)

Pick glass: Handy Reed Pick glass helps in checking the reed pick of the fabric. It also helps in checking the weaving, dyeing & printing defects in the fabric if any is made.

Needle threader: A needle threader is a device for helping to put thread through the eye of a needle. Many kinds exist, though a common type combines a short length of fine wire bent into a diamond shape, with one corner held by a piece of tinfoil or plastic.



Fig.2.1.72: Needle threader



Fig.2.1.73: Nonwoven Non-fusible Backing Paper

Nonwoven Non-fusible Backing Paper: It is made of man-made fibers bonded together to form a paper-like sheet. Nonwovens (no stretch) are best for medium- to heavyweight fabrics with a slight to very crisp hand. Nonwovens with a crosswise or all-direction stretch can be used for soft to moderate shaping. Fusibles today are fast, secure and easy to use.

Hand embroidery book: Used for learning hand embroidery.



Fig.2.1.75: Fabric Glue



Fig.2.1.74: Hand embroidery book

Fabric Glue: It provide temporary or permanent ways to attach fabric without sewing.

Surface ornamentation material (Beads, Sequins): Decorative material used for decoration of clothes.



Fig.2.1.76 (a): Beads



Fig.2.1.76 (b): Sequins

Buttons: are attached to garment by hand stitching or machine stitching



Fig.2.1.77: Buttons



Fig.2.1.78: Hooks

Hooks: are attached to garment with the help of needle and thread

Trims: Trim or trimming in clothing and home decorating is applied ornament, such as gimp, ribbon, ruffles.



Fig.2.1.79: Trims



Fig.2.1.80: Lace

Lace: A fine open fabric of cotton or silk, made by looping, twisting, or knitting thread in patterns and used especially for trimming garments.

Zipper: Attached in lower garments.



Fig.2.1.81: Zipper



Fig.2.1.82: Pant Hooks

Pant hooks: Attached in lower garments.

Sewing Mannequin: it is a type of a doll used by Sewing machine operators or tailors to display or fit clothing.



Fig.2.1.84: Greyscale

Greyscale: It is used for matching colors in the sewed garment against the specifications.



Fig.2.1.83: Sewing Mannequin

Thimble: It is a small hard cup worn for protection on the finger that pushes the needle in sewing



Fig.2.1.85: Thimble

2.1.5 Check the Equipment is Safe and Set-up in Readiness for Use

Keeping a check on your work area is very important. Chaotic areas can create unhealthy and unhygienic work environment leading to accidents and tragedies. Hence, it is always recommended to have a look that the equipment you are going to work on, is safe and ready to use. While working as a sewing machine operator or in such environment you might come across many electrical equipment's, tools and machineries hence here are tips you should always keep in mind before using the appliances.

- Always examine the work area and its surroundings. Never use machines or power tools when they have water on them or if they are exposed to wet conditions like water spillage (even accidentally).
- While using electrical appliances like iron etc. always carry-out a visual check before plugging-in.
- Make sure that the equipment's plugs or connectors are not damaged or are not having any broken/ loose wires.
- Before plugging in, inspect the machinery and make sure that the electric switch on the machinery is off before turning it on for use from the main switch.
- Always consult health and safety department if there are any stains or spark marks present on the equipment to make double assured that it's safe to use.



Fig.2.1.86

- Before turning on any equipment make sure to look around the area to make sure that there is no hazardous material, in order to have healthy working.
- Equipment which was not frequently used in the past should not be used immediately without any inspection, make sure to get it inspected and oiled / greased if needed.
- Always check for the damaged parts before using any product, and if any part that appears damaged should be cautiously inspected and send it for repair. Any part that is damaged should be properly renovated or replaced by a qualified technician only. Do not use if any switch does not turn on and off properly.
- Do not operate the machine without having the safety guards on it to avoid any unwanted accident at the work place.
- Make a basic checklist of your workstation and go through before starting to use the machine for e.g. look for any dull, rusty or bent needles and first replace them before using the sewing machine.
- Always look for your safety guards like eye guard or Fig.guard to avoid needle injury etc. and make sure to have them if your job requires.
- Make sure the equipment is set up in readiness for use i.e. it should be properly greased if needed and all parts and functioning efficiently.
- Before using equipment make sure to look for a label which denotes the trademark for 'safety' and you should be well aware about when was the last time a quality check was conducted on equipment. This allows the operator to understand machine's capability and its readiness for use.

2.1.6 Types of Threads

Sewing Thread

A long, thin, small diameter yarn or twisted strand, usually treated with a surface coating or lubricant or both, intended to be used to stitch one or more pieces of material or an object to a material are referred to as sewing threads.

Knowledge of sewing thread

Structure and manufacturing process of the sewing thread, usual textile products such as cotton thread, silk thread, etc. have been used as sewing thread before. Nowadays, however, chemical fiber products such as polyester thread, nylon thread, etc. are largely used in accordance with materials or applications. These threads are dissimilar from one another in structure and manufacturing.

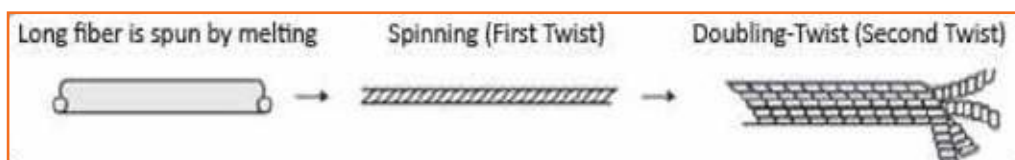

Fig.2.1.87 (a): Thread Structure

Spun thread (Cotton thread, Synthetic spun thread) Short staple fibers produced by a series of twist applied to the staple (Short fiber) is known as spun thread.



Fig.2.1.87 (b): Thread Structure

Mono filament thread this thread is just the same as long fibre that is spun by melting and a long yarn without twist.

Different types of threads

1. **Rayon:** Rayon is the most popular fiber used for embroidering. Its shine and softness makes it a cheaper alternative for silk. Stitches made with rayon threads are smooth and are responsible for higher quality embroidery. However, using rayon is disadvantageous because over time, its quality deteriorates and is quite high maintenance in that regard.



Fig.2.1.88: Rayon Thread



Fig.2.1.89: Polyester Thread

2. **Polyester:** Polyester is a fiber produced from the synthetic processing of polymer resins. It can be made to have a matte finish or a high shine finish, similar to silk as well. Unlike rayon, polyester does not fade or shrink when washed. It is economical and suitable for all types of sewing. It/s color fastness and strength are the major reason why it is the most preferred medium of stitching.

3. **Nylon:** This is another synthetically produced thread with good strength. However the disadvantages are many, like, not being heat resistant, not colourfast (becomes yellow over time) and also becomes brittle through laundering and exposure.



Fig.2.1.90: Nylon Thread



Fig.2.1.91: Cotton Thread

4. **Cotton:** This is the only 100% natural fiber thread made for high speed machines. These threads performs beautifully in machines and has a soft sheen. Embroidery floss is made up of 6 strands that can either be separated or kept together. This is usually used for cross-stitch.

5. **Wool:** A popular animal fiber, wool has a very soft look when it is stitched. While it is not very reflective, it has a soft texture and has a soft look when stitched.



Fig.2.1.92: Wool

Basics of thread construction

All conventional sewing threads begin their production cycle as simple yarns. These basic yarns are produced by twisting together relatively short fibers or fine continuous filaments.

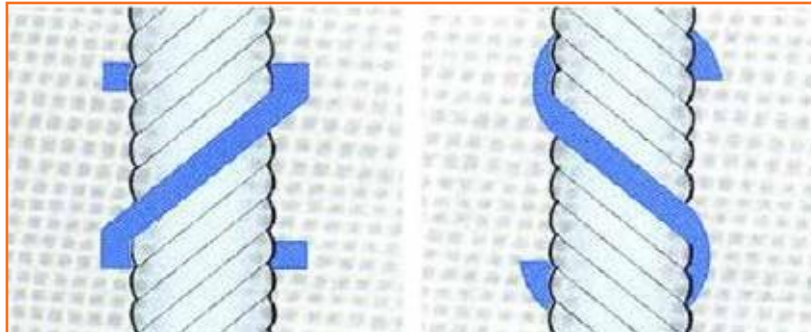

Fig.2.1.93: Basics of thread construction

Some terms used in the context of thread construction are:

- **Twist:** The 'twist' of a thread refers to the number of turns per unit length required to hold the fibers / plies together to give the yarn / thread substance the required strength and flexibility. A thread with an excessive twist is also likely to give trouble while sewing due to 'twist liveliness', which can cause snarling, loops, knots and possible spillage that prohibit stitch formation.
- **Twist direction:** Direction of twist is identified as 'S' for left twist and 'Z' for right twist. Most single needle lock stitch and other machines are designed for 'Z' twist threads. 'S' twist thread untwists during stitch formation.

Ply and cord: Yarns with many components are twisted together to form ply thread. Most commonly used are 2, 3 or 4 ply threads. Threads are twisted together to give corded thread. used are 4, 6 or 9 cord.

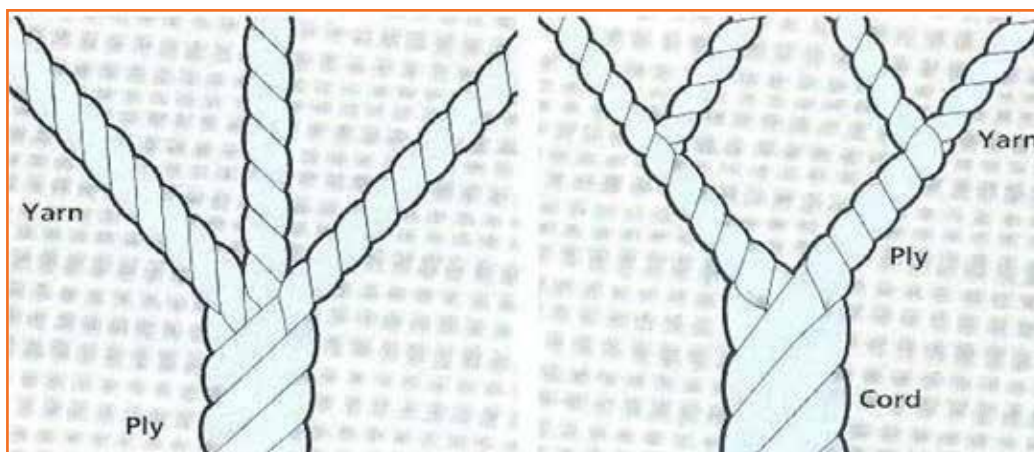

Fig.2.1.94: Ply and Cord of Thread

Sewing Thread Numbering

The thickness of sewing threads is defined by Tex. or Tkt. (Ticket). And these two thread numbering terms are widely used. A same thickness of thread will have two different Figs in these two systems.

Tex Numbering : Tex is a metric system of textile yarn and thread numbering. Tex is defined as weight of 1000 meters thread in grams. For example, Tex 50 means a length of 1000 meters of thread will gives 40 grams of weight.

GENERAL GUIDELINES FOR THREAD SIZE SELECTION			
SEWING THREAD SIZES BY TEX	FABRIC WEIGHT (GSM)	FABRIC WEIGHT (oz/yd ²)	GARMENT EXAMPLES
18, 24	65 - 140	2 - 4	T-shirts, Lingerie
24, 27, 30	140 - 200	4 - 6	Shirts, Dresses
30, 40	200 - 275	6 - 8	Light-Weight Bottoms
40, 60	275 - 400	8 - 12	Light-Weight Denim
60, 80, 105	400 - 500	12 - 15	Heavy-Weight Denim

Fig.2.1.95: Thread Size Selection

2.1.7 Needles

Parts of a sewing machine needle

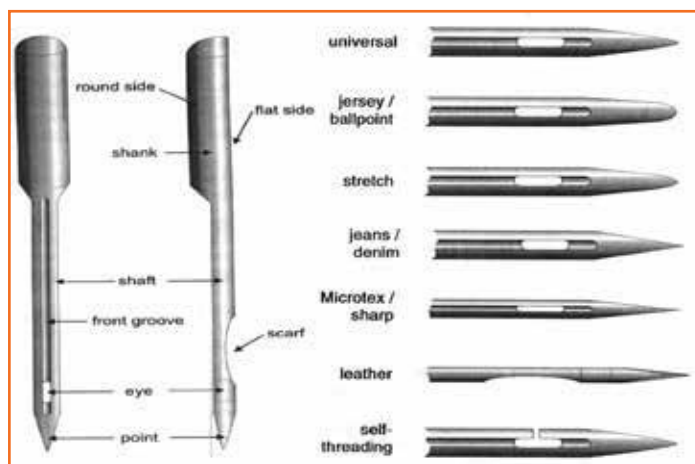

Fig.2.1.96: Parts of a sewing machine needle

- **Shank:** Top of needle that inserts into machine; most often has round needle in right position.
- **Shaft:** Body of needle below shank. Shaft thickness determines needle size.
- **Front groove:** Slit above needle eye, should be large enough to “cradle” thread.
- **Point:** Needle tip that penetrates fabric to pass thread to bobbin-hook and form stitch. Shape of point varies among needle types.
- **Scarf:** Indentation at back of needle. A long scarf helps eliminate skipped stitches by allowing bobbin hook to loop thread more easily.
- **Eye Hole:** Eye Hole in end of needle through which thread passes. Needle size and type determine size and shape of eye.





















Tip point	Symbol	Shape of the needle tip	Shape of point	Application and feature
Sharp and slim type point	Spi			Light-weight fabrics, light-weight leather
Regular type point	R			General fabrics Mainly for button sewing Slim shape and J point at needle tip, for high gauge knit
Butt type point	But			
Slim point	S			
J ball point	J			For general knit, suitable for standard material as well
B ball point	B			
U ball point	U			For relatively coarse knit, ball is \varnothing 1/3 trunk For elastic materials ball is \varnothing 1/2 of trunk
Y ball point	Y			
Flat tip shape	LL			45° twisted type knife needle mainly for leather goods 45° reversely twisted type knife needle mainly for leather goods
	LR			

Fig.2.1.97: Types of Needle Points

Selection of needles

When we select the needle for a specific fabric, we have to decide on two things:

- Needle thickness
- Point shape

Choice of Needle Thickness

We sew some rough cloth using different needles and check the seams. If the needle is not right, we can see the damage to the cloth by pulling it slightly.

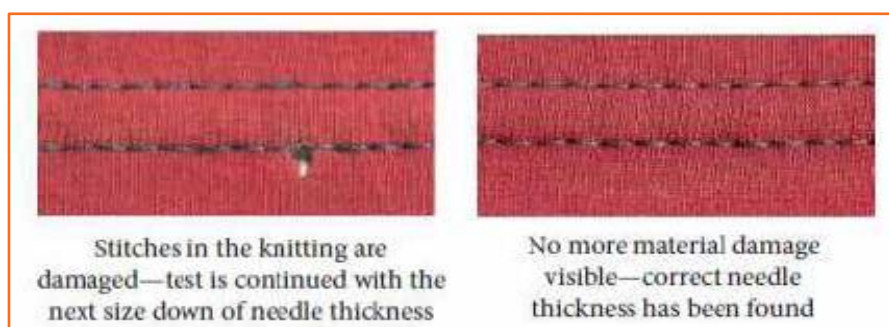

Fig.2.1.98: Choosing Needle Thickness

Choice of Needle Point

The needle points are of 2 types, cut points and cloth points.

1. **Cut points/Sharp point:** These points have a sharp tip to cut through the cloth. These are used for stitching leather products and clothes.



Fig.2.1.99: Cut Point of Needle

2. Cloth points: These have a slightly rounded tip and can cut through the cloth without damaging it. The cloth points can be round or ball points.

- » Round points: These are rounded at tip but are thin and sharp. Such points are used for woven fabric so that the needle can get through the fibers inside the weaves.



Fig.2.1.100: Round Point of Needle

- » Ball points: Used for knitted fabrics, these points are thicker and more rounded at the tip. They shift the yarns and pass through, avoiding holes and fabric damages.



Fig.2.1.101: Ball Point of Needle

Needle Numbering System

There are two number systems associated with sewing machine needles:

- 1. European labelling system:** European sizes range from 60 to 120, 60 being a fine needle and 120 being a thick heavy needle.
- 2. American labelling system:** The American system uses 8 to 19, 8 being a fine needle and 19 being a thick heavy needle.

American	European
8	60
9	65
10	70
11	75
12	80
14	90
16	10
18	110
19	120

Fig.2.1.102: Sew Machine Needle Size

NEEDLE	SPUN THREAD	FILAMENT THREAD	CLOTH MATERIAL
No.5	No. 120	No. 100	Glossy silk, Synthetic ultralight weight (satin etc.)
No. 7 to No. 8	No. 100	No. 80 to No. 100	Same as above
No. 9 to No. 10	No. 80	No. 60 to No. 80	Light-weight silk, satin, crepe de chine, georgette, voile, knit 20G to 26G
No. 11 to No. 12	No. 60	No. 50 to No. 60	Light-weight calico, broadcloth, light-weight wool, knit/double 16G to 20G

No. 13 to No. 14	No. 40 to No. 50	No. 50	Normal broadcloth, wool cloth, general fabric
No. 16	No. 30 to No. 40	No. 40	General heavy-weight fabric (overcoat, etc.) water-proof cloth
No. 18	No. 20 to No. 30	No. 20 to No. 30	Bed-clothes, bags, vinyl shoes
No. 19	No. 10 to No. 20	No. 10 to No. 20	Leather shoes, sheets
No. 20 to No. 21	No. 10	No. 8 to No. 10	Leather shoes, tents
No. 23 to No. 24	No. 8	No. 8	Extra heavy-weight materials, tent, sheet.

Fig.2.1.103: Materials to be used as the product specification

UNIT 2.2: Stitch Components to Produce Apparels

Unit Objectives

At the end of this unit, participants will be able to:

1. Adjust the machine.
2. Ask questions to obtain more information.
3. Estimate the expected length of time for the process.
4. Perform a test sew run.
5. Know the different types of stitching and seam.

2.2.1 Adjusting the Machine

2.2.1.1 Threading



Step 1: This is where the thread goes. If you have a cap or stopper put it on after you put the thread on. Also put the side of the thread with the little cut to the back or bottom.



Step 2: Allow the string to unwind and put it through this hoop. Mine can also snap in from the back but usually with older machines this is a hoop.



Step 3: This can also be a loop but mine slides in through the back.



Step 4: From the tension bring the thread up and from right to left put it through the hole here.



Step 5: Then bring it down from the take up lever into the coiled thread guide.



Step 6: Then into the next thread guide.



Step 7: Then thread the needle front to back or right to left depending on your machine. Pull enough thread through so that it does not pull out when the needle moves 5-10 inches.



Step 8: Insert the bobbin.



Step 9: Pull the string out tight and set the bobbin into the tray. Insert the thread into the metal notch and pull back.

2.2.1.2 Using the Bobbin Winder

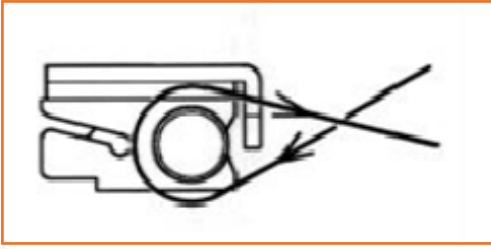

- Step 1:**
- Place spool of thread on spool pin.
 - Slide spool pin holder/cap firmly over rim of spool to prevent thread from tangling.
 - Push bobbin winder pin to far left if it is not already there.
 - Pass the thread from spool through thread guide

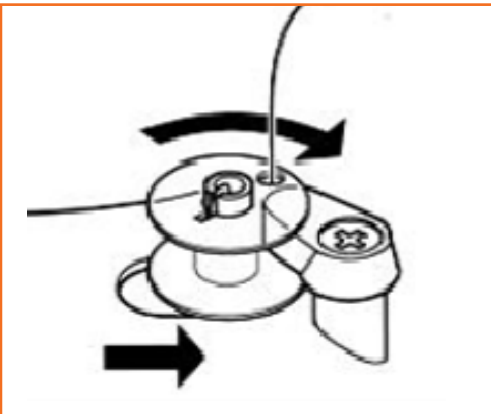

- Step 3:**
- Place bobbin onto pin.
 - Push bobbin winder pin to the right. This will stop the needle from moving.

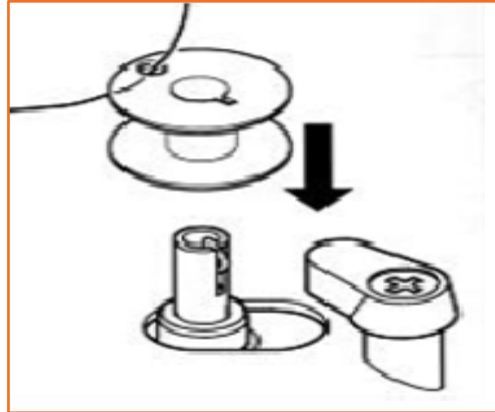

- Step 2:** Pass thread end, from inside, through small hole in rim of bobbin

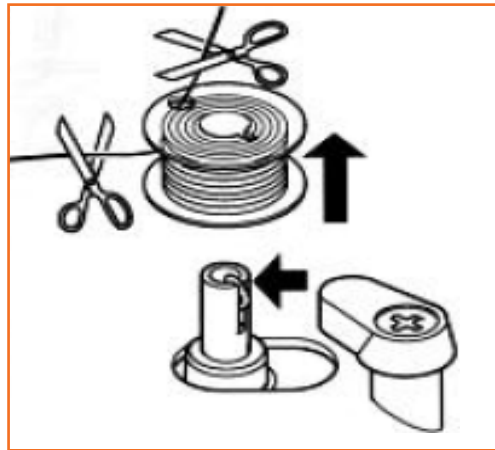

- Step 4:**
- Holding thread end, step on speed controller to run machine until desired amount of thread is wound.
 - Cut thread; push bobbin to the left and remove it from bobbin winder pin

Treadles

A treadle is a part of a machine which is operated by the foot to produce reciprocating or rotary motion in a machine such as a weaving loom (reciprocating) or grinder (rotary). Many of the early machines were powered by a treadle mechanism. The treadle was operated by pressing down on it with a foot, or both feet, to cause a rocking movement. This movement spins a large wheel on the treadle frame, connected by a thin leather belt to a smaller driving wheels on the sewing machine.

Tension adjustment

To make a basic adjustment, adjust the bobbin spring; tighter if the bobbin thread shows on the upper layer, and looser if the needle thread shows on the under layer.



Fig.2.2.1: Bobbin Case



Fig.2.2.2: Bobbin

Adjusting the needle

Needle is chosen and adjusted as per the requirement, i.e. it depends on what thread and what material is been used. While selecting and adjusting needle for specific fabric, two things must be considered:

1. Thickness of a needle
2. Point-shape

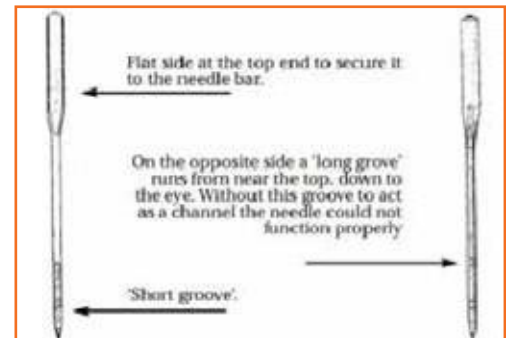

Fig.2.2.3: Adjusting the needle

Choice of needle point

- **Cut Points:** These points have sharp tips to cut through the cloth therefore they are used for stitching leather products and clothes.
- **Cloth Points:** They have slight round shape and can cut through the cloth without damaging it. Suitability of thread and needle is also based on cloth material for e.g. for light weight silk, satin or crepe cloth point needles can be used as they cut through the cloth without providing them any damage.

2.2.1.3 Replacing a Needle

It always happens. You're pushing that fabric through, pushing that pedal to the grindstone, and it happens. You hear the loud pop and feel a tiny prick against your face or arm. You've broken a needle. But there's no use crying over a broken needle. They're fast and easy to replace, as long as you have some back up needles around. Nowadays, sewing machines use universal needles, which will fit just about every machine.



Step 1: Hold the needle with your left hand and undo the screw at the top of the needle with your right hand.



Step 2: Remove the needle by pulling down and away from the needle clamp.



Step 3: With the flat side towards the back, push the new needle up inside the needle clamp as high as it will go.



Step 4: Use your fingers initially and then your tool of choice to tighten the needle clamp screw. The tighter you can make this, the better. A loose clamp may leave the needle down in the fabric you are sewing.



Step 5: Re-thread your needle, pushing the thread from front to back.

2.2.2 Pre-sewing Activities

Before sewing a garment, the sewing machine operator should.

- Check that equipment is safe and set up in readiness for use. Perform a machine, needle and spool check. Do a sample run to check thread tension.
- Check that the materials to be used are free from faults. Go through all the material required for constructing the garment. Do fabric, thread and trims checking before sewing.
- Ensure the materials used meet the specification matching. Go through the spec sheet and make sure the materials meet the specifications provided by the buyer.

2.2.3 Ask Questions to Obtain More Information

Ask questions to obtain more information on tasks when the instructions are unclear and finalize the stitching option with supervisor in case of queries:

- It is important to ask questions rather to act like a dumb or a super heroic figure to the group or the team at your work place.

If you haven't been told
or
you don't understand
Ask

Fig.2.2.4: Ask questions

- It is important to pay attention, while demonstration or details are been given/taught on how to perform your certain job role, however even if you haven't been told or maybe you were unable to understand at once, it's always suggested.
- As a sewing machine operator it is very important for you to be proactive at all times like pro-active in learning or asking things you aren't sure about and pro-active and swift in working as well.
- Flawless working can be attained only if you put in endless efforts of practicing or clearing all your doubts when and wherever you require.
- Even if you think it's the silliest thing ever which I have not understood or people would make fun of; ignore that thought right then and there. Ask! It's much better to ask rather to keep quiet.
- When you are not clear about the instructions like what and how you have stitch any particular garment it's always suggested to look for a team leader or a supervisor for guidance and help on the subject.
- If you feel hesitant in directly approaching your supervisor tell them to make you sit with someone who is efficient in the work so that you can learn from one of the group mates at your ease.
- More you ask, more efficient you become.
- Asking the query of any sort of doubt like non-understanding of the subject or any un-cleared / confusing statements can also help using the resources right way and not just wasting them trying rather than asking the expertise.
- It is okay to ask even after the training period if you are un-sure about any statement related to your role in the industry / company.

2.2.4 Estimate the Expected Length of Time for the Process

Off Standard Time

Time is considered off standard when operator is not able to work due to:

- Unavailability of work
- Power Failure
- Machine Breakdown

In simpler terms the amount of time in a day when the standard conditions are not provided to operator for working is called off standard time



Fig.2.2.5

2.2.5 Perform a Test Run

Perform a test run if the sewing machine is running smoothly and with full efficiency. If not, then check the following and adjust the machine:



Step 1: **Cleaning and oiling:** Check if the machine has been cleaned and oiled properly. With the presser foot up, try to run the machine at full speed for one minute. If you hear a noticeable discrepancy in speed then the machine surely needs some lubrication. Remove the top cover (if machine has one.) If not, you should be able to find holes on top of it. Apply only a drop of SEWING MACHINE OIL (not 3 in 1 oil or any other kind of oil or rust inhibitor). Next, reach the bottom of your machine. After removing any dust, lint, broken needles debris and straight pins, apply a drop of oil to each moving part. By turning the hand wheel slowly (always towards you for 98% of them), you will see all the moving parts joints that needs to be oiled. Many parts already have a small hole especially for oiling.

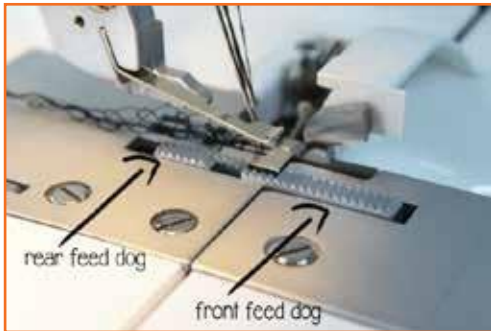

Step 2: **Check feed dogs:** Remove the feed dog, clean the feed dogs. Try to pass a rag under them and with an old needle or narrow tool, remove the lint inside the feed channels. Put back the needle plate. If your machine is equipped with a FEED DROP, be sure the feeds are set at UP position. By turning the hand wheel (towards you), check to see if the feeds make their movement.



Step 3: **Look for upper tension:** Most sewing machine problems are caused by thread tension. Learn this basic principle right now: the upper tension determines your UNDER stitch. And the bobbin (bottom) tension determines your UPPER stitch. Unless you are experimented to dismantle the upper tension unit or if it's explained in your manual, follow this simple technique. Tension discs are often disrupted by pieces of broken thread, lint and dust. This cause a gap between the tension discs and no pressure is applied to the thread resulting of thread loops underneath. Take an 8" length of thread and make 3 to 4 knots in it (as pictured below). Thread your tension system with this piece of thread a few times in all directions. This will remove any lint residue between the tension discs. Try it for the first time with the presser foot UP and then with the presser foot DOWN. When the presser foot is down and the tension dial set at number 4, you should be able to feel a tension when pulling the thread. If so, the upper tension system is working properly.



Step 4: The bottom bobbin: Check also for the condition of the bobbin winder rubber tire. If you can see cracks and worn flat surfaces, replace it. This very popular item is available at any sewing shop for a dollar or so. When winding a bobbin, check to see if the thread winds evenly from each side of the bobbin. Then check the bottom of your bobbin case. Remove any lint pancake. Install your bobbin in it. By pulling the thread, you should feel a very soft tension on the thread. If not, some clogged lint may be laying between the small tension spring and the bobbin case itself.

Now perform the test run (Again) and must experience the following observations to make sure the machine is working properly.

- Firstly, run the machine at medium speed for the first stitch row.
- Check underneath: the stitch should be identical to the top one. No loops, only a tight stitch. If any loops are found underneath, raise the upper tension slightly and make a second stitch row.
- Try also the reverse stitch a few times while sewing (do not stop to engage the reverse). Make sure the thread does not break. Check also for loops underneath on the stitches made with the reverse.
- If everything is good so far, run the machine at full speed making a few stitch rows. If your machine is equipped with the zigzag, try it. The zigzag stitch should be the same on top and bottom.

2.2.6 Check That the Material is Free from Faults

It is important to go through and inspect every garment which is produced in the garment factory. Stitching operations are one of the important aspects of the garment factories and every single thing should be very minutely checked before sending for the final finishing or displaying. Any part of the machinery or the garment which you would be required to work on, should be checked that the material about to be used is fault-free. Any faulty material found, should be reported to the responsible authority immediately, it should be sent for replacement. While using the material the commonly seen faults are in: faulty needle, unusual thread, wrong stitching pattern however fabric defect over shadows all as it is the most important of all in first place hence should be checked very clearly and thoroughly before making it in use.

2.2.7 Seam

Seam is a joint consisting of a sequence of stitches uniting two or more pieces of material(s) and is used for assembling parts in the production of sewn items.

Seam Classes

Class 1 – Superimposed seam

Class 2 – Lapped seam

Class 3 – Bound seams

Class 4 – Flat seams

Class 5 – Decorative/Ornamental stitching

Class 6 – Edge finishing/neatening

Class 7 – Attaching of separate items

Class 8 – Single ply construction

Types of Seam

Superimposed Seams: These generally start with two or more pieces of material superimposed over each other and joined near an edge, with one or more rows of stitches. There are various types of seams within the SS class. A superimposed seam can be sewn with a stitch 301 or 401 to create a simple seam. The same seam type can also be sewn with stitch class 500 (Over edge stitch) or Combination stitches (i.e. stitch class 516). The purpose is to create neat load bearing seams for lingerie, shirts, etc.

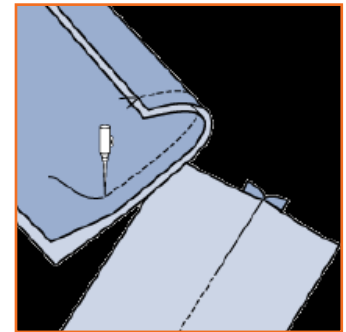

Fig.2.2.6: Superimposed Seams

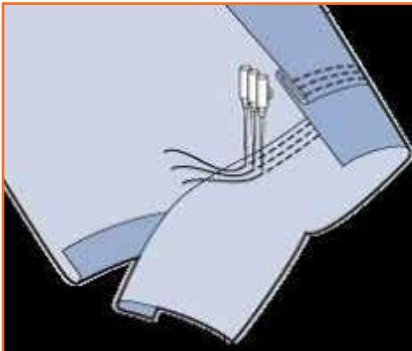

Fig.2.2.7: Lap Felled Seam

Lap Felled Seam: The Lap Felled type, involves only one stitching operation - a strong seam with fabric edges protected from fraying. Commonly used for making up jeans or similar garments.

Bound Seams: These are formed by folding a binding strip over the edge of the plies of material and joining both edges of the binding to the material with one or more rows of stitching. This produces a neat edge on a seam exposed to view or to wear.

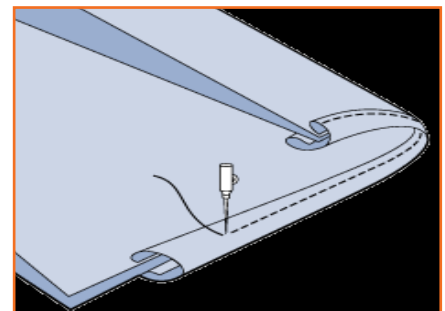

Fig.2.2.8: Bound Seams

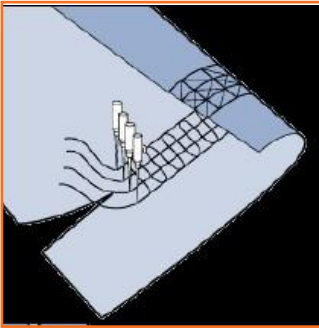

Fig.2.2.9: Flat Seam

French Seam: French seaming involves 2 stitching operations with an intervening folding operation - a flat, folded seam with only one row of stitching visible on the top surface. French seaming involves 2 stitching operations with an intervening folding operation - a flat, folded seam with only one row of stitching visible on the top surface.

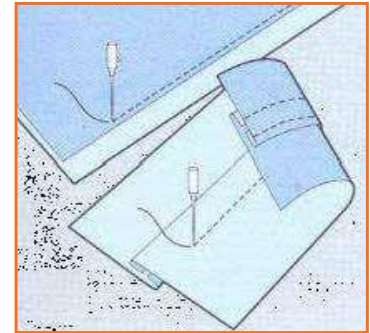

Fig.2.2.10: French Seam

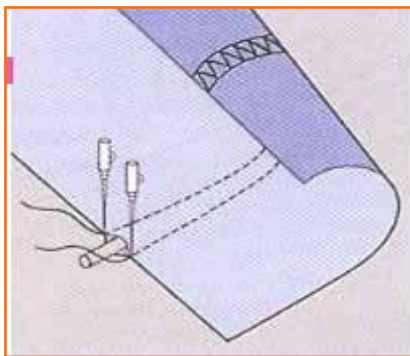

Fig.2.2.11: Decorative Stitching

Decorative/Ornamental stitching

On a single ply of material, an ornamental stitch is created using along straight and/or curved lines or even while following an ornamental design. A more complicated process in this regard is the piping stitch, which includes many forms of producing a raised line along the surface of the fabric.

The result of using this stitch is decorative components like braiding, pin tucks etc. This seam is comprised of a minimum of one component.

Edge finishing/neatening

Edge finishing involves folding or covering a single ply of the material with a stitch.

Its applications include serging trouser panels, flys, facings, etc.

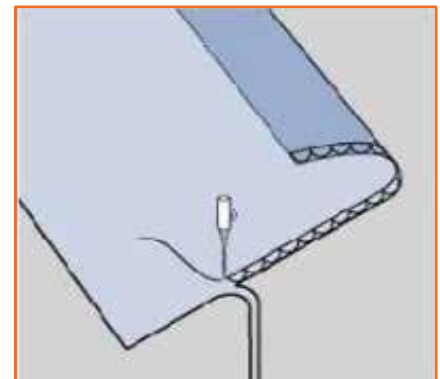

Fig.2.2.12: Edge finishing

2.2.8 Stitches

A Stitch in one unit of conformation of thread resulting from repeatedly passing a strand or strands and/or loop or loops of thread into or through a material at uniformly spaced intervals to form a series of stitches. Stitch classification is based on structure of the stitch and method of formation.

Stitch classification: Stitch classification is based on structure of the stitch and method of interlacing.

100 Class stitch(Single thread chain stitch): Using one needle thread and one blind looper.

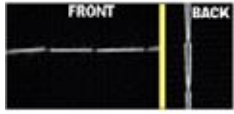

Diagram	Stitch class	Thread count	Typical uses
	101 Class	One thread	Basting, or light construction
	103 Class	One thread	Blind stitch for hemming
	104 Class	One thread	Blind stitch for hemming

Fig.2.2.13: 100 Class stitch

200 Class stitch(Hand Stitch) - Single thread hand sewn stitch: Using one needle thread.

Diagram	Stitch class	Thread count	Typical uses
	202 Class	One Thread	Basting, tacking or repairs
	205 Class	One Thread	Pick stitch - topstitching

Fig.2.2.14: 200 Class stitch

300 Class stitch (Lock Stitch) - Two or more thread lock stitch: Using Needle Thread(s) and One Bobbin Hook Thread.

Diagram	Stitch class	Thread count	Typical uses
	301 Class	Two threads	Seaming multiple plies
	304 Class	Two thread	Zig-zag stitch; a stretch lockstitch
	306 Class	Two thread	Blind stitch
	315 Class	Two threads	Three step zig-zag

Fig.2.2.15: 300 Class stitch

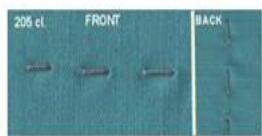
400 Class stitch(Chain Stitch) - Multi-thread chain stitch: Using one or more needle threads and one or more looper threads.



Diagram	Stitch class	Thread count	Typical uses
	401 Class	Two threads	Seaming multiple plies with moderate stretch
	404 Class	Two threads	Topstitching or seaming with stretch
	406 Class	Three threads	"Bottom cover stitch"; a (greater) stretch chain stitch

Fig.2.2.16: 400 Class stitch

500 Class Stitch(OverEdge Stitch) - Multi-thread over edge chain stitch: Using needle thread(s) and looper thread(s).



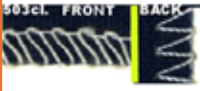

Diagram	Stitch class	Thread count	Typical uses
	501 Class	One thread	One needle over edge stitch for serging / "blanket stitch"
	502 Class	Two thread	One needle over edge stitch for serging
	503 Class	Two thread	Over edge stitch for serging with crossover on edge of fabric
	504 Class	Three thread	Over edge stitch for serging and light seaming

Fig.2.2.17(a): 500 Class Stitch - Multi-thread over edge chain stitch





Diagram	Stitch class	Thread count	Typical uses
	512 Class	Four Thread	Mock safety stitch for seaming with wide bite and greater stretch for knits
	514 Class	Four Thread	Over edge stitch for seaming with wide bite and greater stretch for knits
	515 Class	Four Thread	True safety stitch for seaming with good stretch for wovens and knits
	516 Class	Five Thread	True safety stitch for seaming with good stretch for wovens and knits

Fig.2.2.17(b): 500 Class Stitch - Multi-thread over edge chain stitch

600 Class Stitch(Flat Stitch) - Multi-thread cover stitches:



Diagram	Stitch class	Thread count	Typical uses
	602 Class	Four thread	Cover stitch or seaming knits
	605 Class	Five thread	Cover stitch
	607 Class	Six thread	Wide cover stitch

Fig.2.2.18: 600 Class Stitch - Multi-thread cover stitches

Stitches Per Inch for Woven Garments

The stitch length is measured by measuring the number of lengths of thread found within one inch. As you can see here, there are approximately 9 SPI sewn in this seam.



Fig.2.2.19: Stitch length measurement

Garments	SPI	Comments	Garments	SPI	Comments
Denim Jeans, Jackets, Skirts	7 – 8	Fewer stitches per inch generally will give a more contrast stitch appearance.	Children's wear	8 - 10	Usually 8 to 10 spi is adequate to provide adequate seam strength and at the same time allow for quicker cycle times .
Twill Pants or Shorts	8 – 10	More stitches per inch will help minimize seam grinning.	Dresses, Skirts	10 - 12	Due to many of the operations being lockstitch, usually 10 – 12 spi is required to provide adequate seam strength.
Trousers, Dress Pants, Slacks	10 - 12	On some operations like serge panels, it may be desirable to use a longer stitch length.	Blind stitch Operations on Slacks, Dresses, Skirts, etc.	3 – 5	A long stitch length is desirable to minimize the dimple or appearance of the needle penetration on the outside of the garment.
Dress Shirt or Blouse	14 – 20	Using more SPI allows the use of smaller diameter threads that will minimize seam puckering.	Buttonsew (4 hole button)	16	Button sew machines are cycle machines with a predetermined number of stitches per cycle.

Casual Shirts, Blouses, Tops	10 - 14	Using more SPI will give more of a tailored stitch appearance and better seam coverage when serging.	Button hole (1/2" purl or whip stitch)	85 - 90	Generally sewn vertically – approx. 85- 90 stitches with a lockstitch buttonhole machine.
---------------------------------	---------	--	---	---------	---

Fig.2.2.20: Stitch length measurement table

Stitch Formation

The lock stitch uses two threads, an upper and a lower. Lock stitch is so named because the two threads, upper and lower, "lock" (entwine) together in the hole in the fabric which they pass through. The upper thread runs from a spool kept on a spindle on top of or next to the machine, through a tension mechanism, through the take-up arm, and finally through the hole in the needle. Meanwhile the lower thread is wound onto a bobbin, which is inserted into a case in the lower section of the machine below the material.

To make one stitch, the machine lowers the threaded needle through the cloth into the bobbin area, where a rotating hook (or other hooking mechanism) catches the upper thread at the point just after it goes through the needle. The hook mechanism carries the upper thread entirely around the bobbin case, so that it has made one wrap of the bobbin thread. Then the take-up arm pulls the excess upper thread (from the bobbin area) back to the top, forming the lock stitch. Then the feed dogs pull the material along one stitch length, and the cycle repeats

2.2.8.1 Steps for Lockstitch



- Step 1:**
- Keep the slide plate open so that the hook-set is visible.
 - Bring needle to its lowest position into the hole through which it reaches the bobbin by slowly moving the hand-wheel.
 - Now, move the needle up using the hand-wheel
 - Needle-thread (Upper-thread) becomes loose when the needle goes up from this lowest position.
 - Blade point of outer hook of the bobbin assembly catches the loop-shaped upper thread and pulls it.
 - Upper thread is then separated at the inner hook thread separating portion.
 - So the needle-thread is taken up by the opposite (or rear) inner hook.
 - At the same time needle-thread on cloth side is separated to the right side of inner hook.

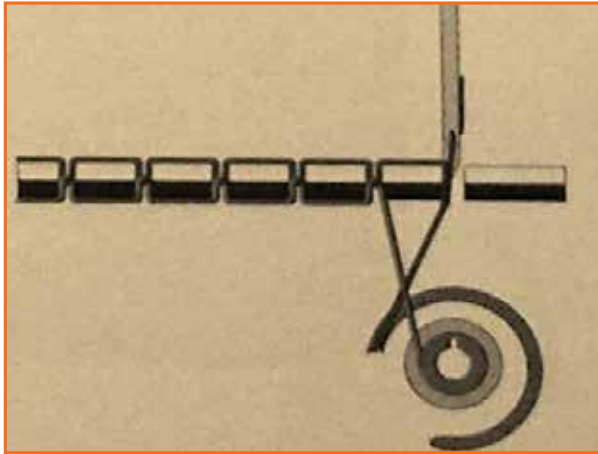

- Step 2:**
- Keep the slide plate open so that the hook-set is visible.
 - Bring needle to its lowest position into the hole through which it reaches the bobbin by slowly moving the hand-wheel.
 - Now, move the needle up using the hand-wheel
 - Needle-thread (Upper-thread) becomes loose when the needle goes up from this lowest position.
 - Blade point of outer hook of the bobbin assembly catches the loop-shaped upper thread and pulls it.
 - Upper thread is then separated at the inner hook thread separating portion.
 - So the needle-thread is taken up by the opposite (or rear) inner hook.
 - At the same time needle-thread on cloth side is separated to the right side of inner hook.

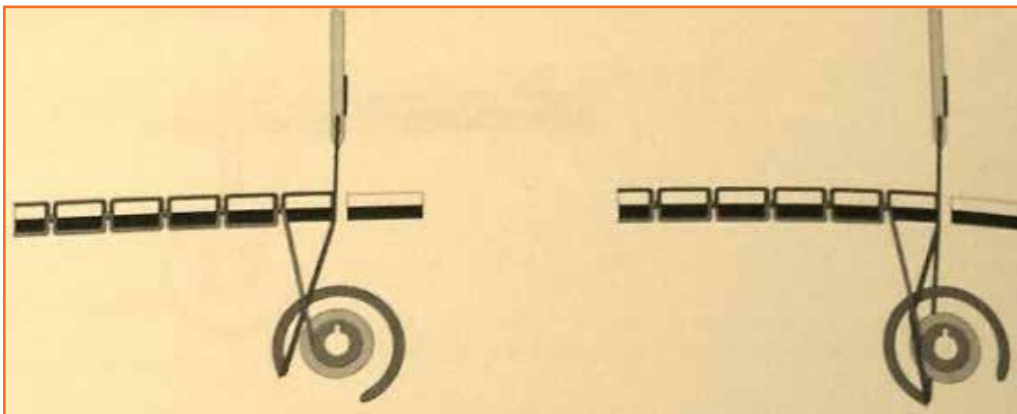

- Step 3:**
- Thus the upper thread is lock-stitched (interlaced) with the lower thread.
 - Stitch formation is completed when the upper thread lifts the lower thread.
 - The feed dog pushes the unstitched portion of the cloth under the presser foot.
 - The needle comes down and goes inside the cloth to repeat from step 1 to 14.

2.2.8.2 Steps for Chain Stitch

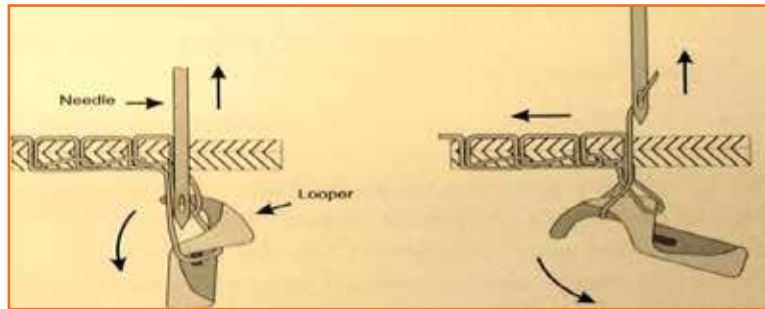

- Step 1:**
- Needle is the lowest position.
 - Upper thread becomes loose when needle goes up from its lowest position.
 - Needle-thread (upper thread) becomes like a loop then the looper catches the needle thread.
 - The needle enters the loop of needle-thread which is widened by the looper.

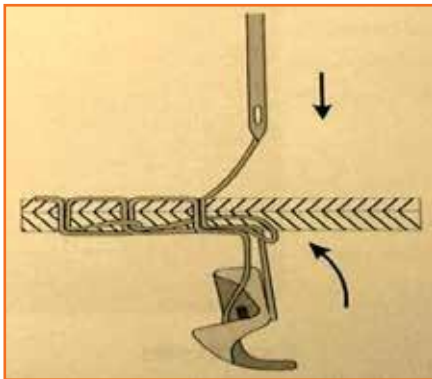

- Step 2:**
- The needle moves up and comes out of the cloth and the unstitched portion of cloth is pushed forward to form a stitch.
 - The looper rotates and removes the loop of the needle-thread it had caught.
 - Also the looper keeps pulling in the needle-thread as it rotates.
 - Needle-bar goes up and needle-thread take-up lever lifts the thread up along with it.

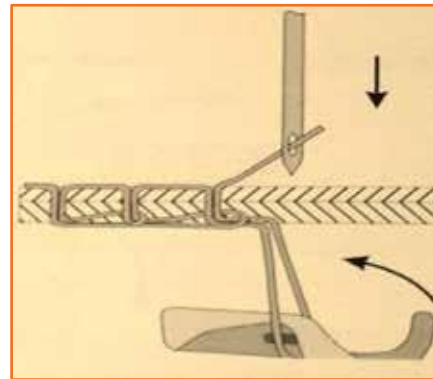

- Step 3:**
- Looper keeps rotating and pulls thread towards its own centre
 - Thread take-up lever tightens the earlier loop of thread which the looper removed in step 6.
 - Cloth feed is finished (feed dog has finished one cycle of feeding) and a stitch is formed
 - Needle again pierces into the cloth and continues to form the next stitch repeating all the step.

2.2.8.3 Stitch at the Normal Speed

The above activity was to understand the formation of lockstitch and chain stitch. Now let's see how to stitch at the normal speed.

- **Step 1:** Attach needle and thread the machine – needle-thread and bobbin-thread.
- **Step 2:** Adjust thread tension using a rough fabric.
- **Step 3:** Put the fabric sample at the left end of the machine.
- **Step 4:** Note the start time to start sewing exercise.
- **Step 5:** Pull the fabric sample with the left hand.
- **Step 6:** Raise the presser foot using the knee lifter.
- **Step 7:** Place the fabric sample under the presser foot such that the start point of the fine line is exactly below the needle point. (Fig.2.2.47)
- **Step 8:** Lower the presser foot.
- **Step 9:** Press the pedal down with the toe of the right foot.
- **Step 10:** Continue to press the pedal down with more force such that machine runs at normal speed (i.e. high speed).
- **Step 11:** Guide the sample with your hands as it moves forward.
- **Step 12:** maintain stitching line along the marked straight line.
- **Step 13:** Stop sewing-machine at the stop mark.
- **Step 14:** Press the back part of the pedal down with the heel of the left foot.
- **Step 15:** Raise the presser foot and pull the sample out.
- **Step 16:** Hold the trimmer in the right hand and trim the threads.
- **Step 17:** Practice by repeating from step 6 to 16 for all 10 lines on the sample.
- **Step 18:** After completion, remove the sample from the machine to the left side. (Fig.2.2.48)
- **Step 19:** Note the end-time.

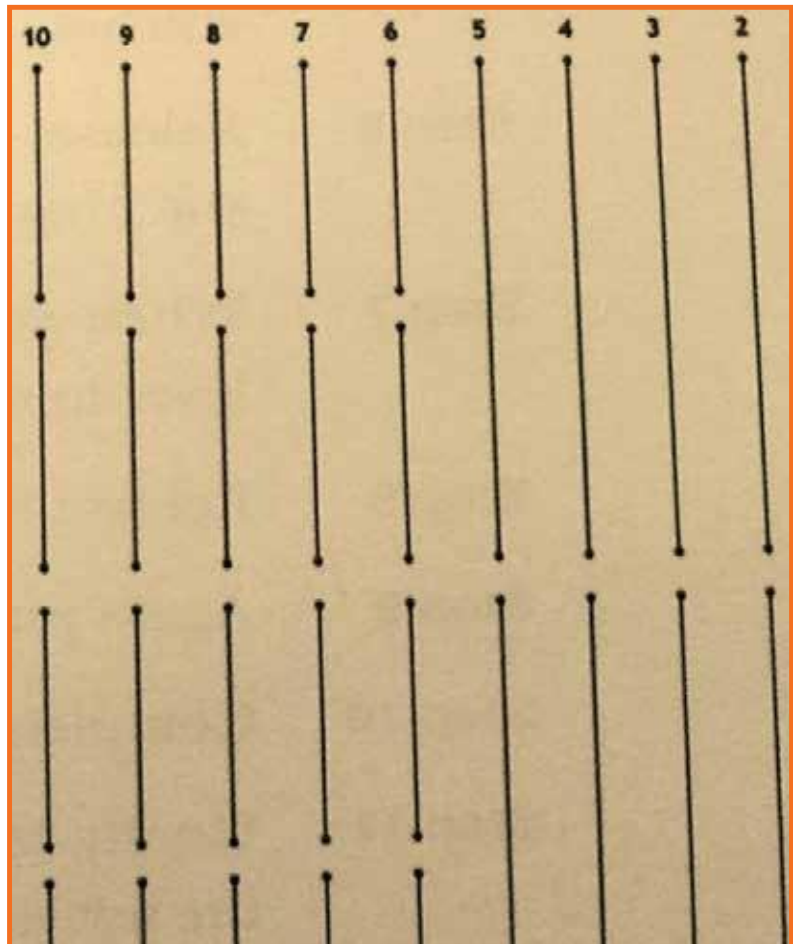

Fig.2.2.21: Stitching at normal speed

2.2.9 Practicing Corner Stitch and Curve Stitch

2.2.9.1 Corner Stitch

- **Step 1:** Attach needle and thread the machine- needle-thread and bobbin- thread.
- **Step 2:** Adjust thread tension using a rough fabric.
- **Step 3:** Put the fabric sample at the left end of the machine.
- **Step 4:** Note the start time to start sewing exercise.
- **Step 5:** Pull the fabric sample with the left hand.
- **Step 6:** Raise the presser foot using the knee lifter.
- **Step 7:** Place the fabric sample under the presser foot such that the start point of the fine line is exactly below the needle point.
- **Step 8:** Lower the presser foot.
- **Step 9:** Press the feed control lever (Reverse stitch lever) to its lowest position.
- **Step 10:** sew 2-3 reverse stitches at low speed.
- **Step 11:** Stop stitching.
- **Step 12:** Release the reverse stitch lever a that the machine can do regular sewing (forward direction).
- **Step 13:** Start sewing at normal speed i.e. high speed.
- **Step 14:** keep stitching along that line.
- **Step 15:** Slow down the speed when the corner comes near.
- **Step 16:** Stop sewing at the corner point.
- **Step 17:** Lower the needle at the corner.
- **Step 18:** Raise the presser foot.
- **Step 19:** keeping the needle in dropped position or lowest position (pierced inside the fabric sample), turn the fabric sample.
- **Step 20:** Align the fabric sample such that the stitching line drawing (after the corner stop point) is in line with the needle point and stitching line.
- **Step 21:** Lower the presser foot.
- **Step 22:** Sew straight stitches.
- **Step 23:** Repeat Step 14-22 at every corner. (Fig.2.2.49)
- **Step 24:** Stop sewing at the sewing end symbol.
- **Step 25:** Press the back part of the pedal down with the heel of the left foot.
- **Step 26:** Raise the presser foot and pull the sample out.

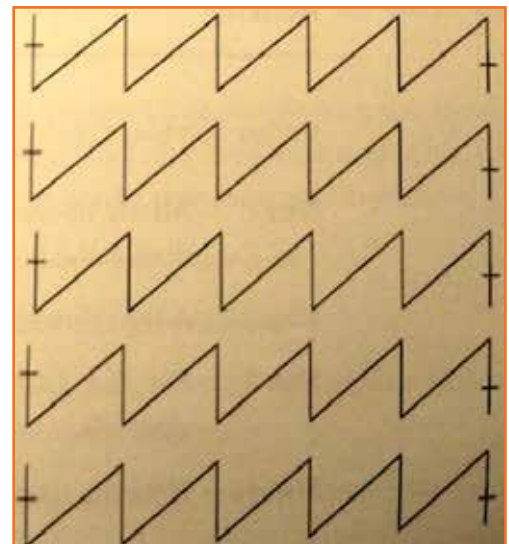

Fig.2.2.22: Corner Stitch

2.2.9.2 Curve Stitching (Left Curve and Right Curve)

- **Step 1:** Attach needle and thread the machine- needle-thread and bobbin- thread.
- **Step 2:** Adjust thread tension using a rough fabric.
- **Step 3:** Put the fabric sample at the left end of the machine.
- **Step 4:** Note the start time to start sewing exercise.
- **Step 5:** Pull the fabric sample with the left hand.
- **Step 6:** Raise the presser foot using the knee lifter.
- **Step 7:** Start sewing at the outermost semicircle of the curves on the left.
- **Step 8:** Place the fabric sample under the presser foot such that the start point of the first line is exactly below the needle point.
- **Step 9:** Lower the presser foot.
- **Step 10:** Press the pedal down with the toe of the right foot.
- **Step 11:** Continue to press the pedal down with more force such that machine runs at a normal speed (high speed).
- **Step 12:** Guide the sample with your hands as it moves forward to keep the stitching on the drawn curve.
- **Step 13:** maintain stitching line along the marked curve.
- **Step 14:** Stop sewing-machine at the stop mark.
- **Step 15:** Press the back part of the pedal down with the heel of the left foot.
- **Step 16:** Raise the presser foot and pull the sample out.
- **Step 17:** Hold the trimmer in the right hand and trim the threads.
- **Step 18:** Practice by repeating from step 6 to 16 for all 7 curves on the sample.
- **Step 19:** Now, practice sewing along the outermost right curve on the worksheet by repeating step 6 – 16 for all 7 right curves.
- **Step 20:** Note the hand movement that helps guide the fabric which must change according to the change in the direction of curve.
- **Step 21:** After completion, remove the sample form the machine to the left side. (Fig.2.2.50)
- **Step 22:** Note the end time

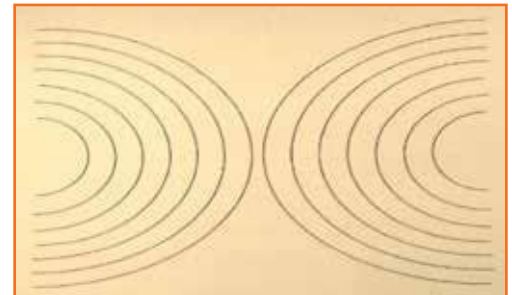

Fig.2.2.23: Curve Stitching

Industry Visit

The purpose of visiting an apparel manufacturing unit is to get hands on knowledge about various processes involved in the work of an SMO. During the visit you have to interact with Sewing Machine Operators and supervisors to understand how work is done in industry. Make sure that you keep a notebook handy and note down any important points that come up during your interaction at the apparel manufacturing unit. When you go to an apparel manufacturing unit, you should:

- Analyze how an SMO adjusts sewing machine for sewing like, threading a machine, attaching bobbin to machine and replacing needle etc.
- Understand the different types of stitches and which type of stitch suits to different fabrics.
- Ask questions to SMOs/supervisors if you have any query.

UNIT 2.3: Stitching a Trouser

Unit Objectives

At the end of this unit, participants will be able to:

1. Recognize the different parts of a trouser.
2. Stitch a trouser.

2.3.1 Types of Pockets, Plackets and Sleeves

Pockets: A pocket is a bag- or envelope-like receptacle either fastened to or inserted in an article of clothing to hold small items

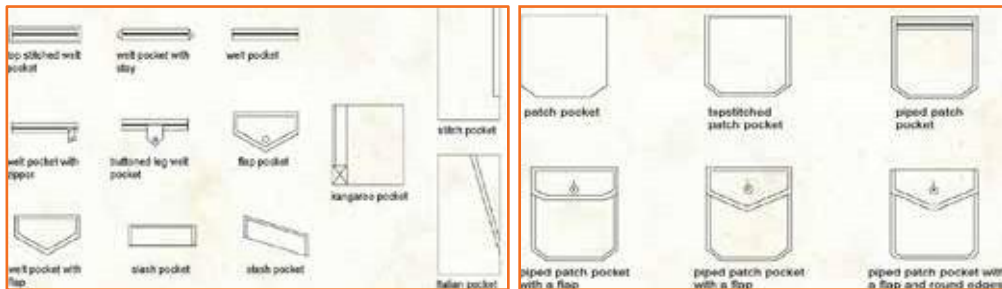

Fig.2.3.1: Types of Pockets

Plackets: A placket is an opening in the upper part of trousers or skirts, or at the neck or sleeve of a garment. Plackets are almost always used to allow clothing to be put on or removed easily

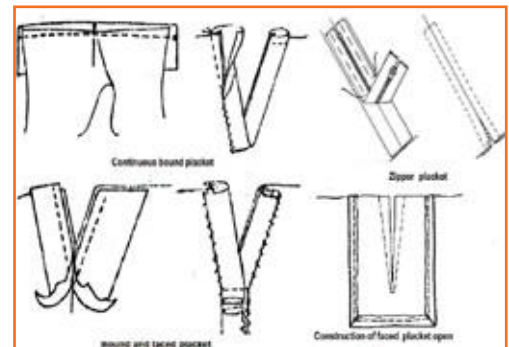

Fig.2.3.2: Types of Plackets



Fig.2.3.3: Types of Sleeves

Sleeves: Sleeve is the part of a garment that covers the arm, or through which the arm passes or slips.

2.3.2 Trouser Stitching

Parts of a trouser

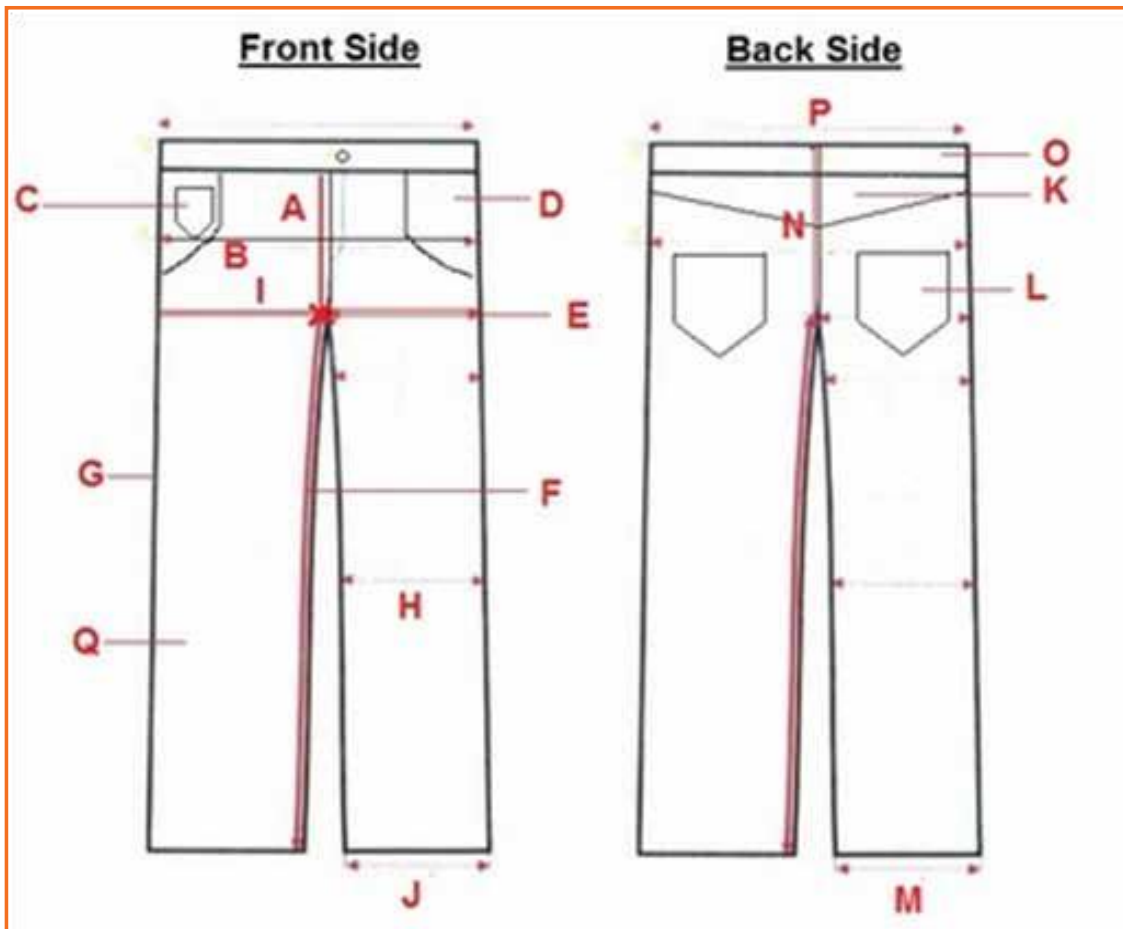
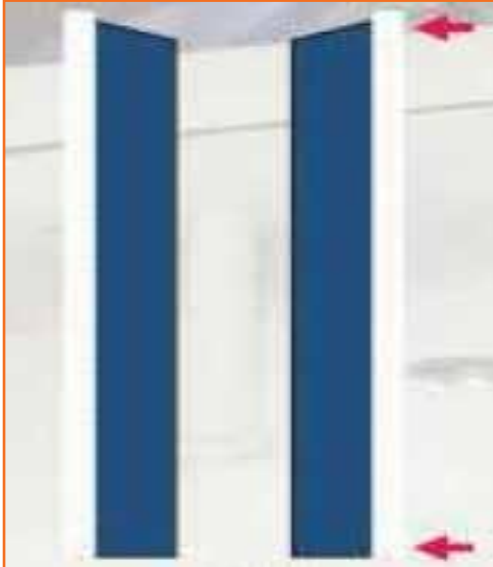

Fig.2.3.4: Parts of a trouser

- A = Front Rise
- B = Hips
- C = Coin Pocket
- D = Scoop Pocket
- E = Crotch (center point)
- F = Inseam
- G = Side seam
- H = Knee
- I = Thigh (crotch to side seam)
- M/J = Leg Opening / Bottom Hem
- K = Yock
- L = Back Pocket
- N = Back Rise
- O = Waist Band
- P = Waist
- Q = Pannel (Back/Front)

2.3.3 Steps for Stitching a Trouser

2.3.3.1 Preparation of Pocket Bag (front)



Step 1: Take both the upper facing pieces and put overlock stitch on the longer straight sides. Make sure the face side of the pieces is on top.

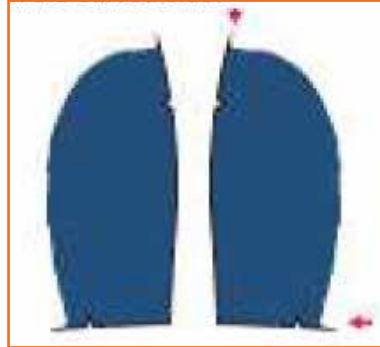

Step 2: Take both the lower facing pieces and put overlock stitch on the curved sides. Again, make sure that the face side of the pieces are on the top.

- Note the notch marks on the lower facing pieces.
- Note that the overlock stitch is on the curved side.



Step 3: Take both of the pocket bag pieces and both upper facing pieces. Keep the upper facing piece over the pocket bag in such a way that the overlock part is facing inside and the stitch is facing upwards.

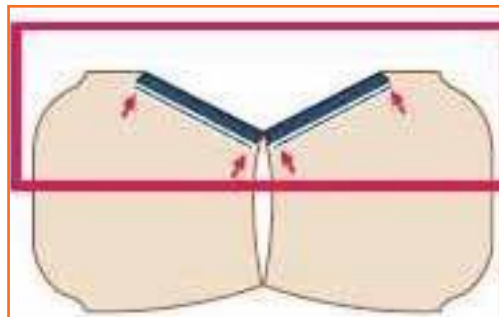

Step 4: Put lockstitch at the edge of the overlock stitch.



Step 5: Take both the lower facing pieces and keep them over the other side of the pocket bag.



Step 6: Put the lockstitch at the edge of the overlock curved stitch.

2.3.3.2 Pocket Attaching (front)



Step 1: Take the two front pieces and keep them on the sewing Fig. with the face side up.

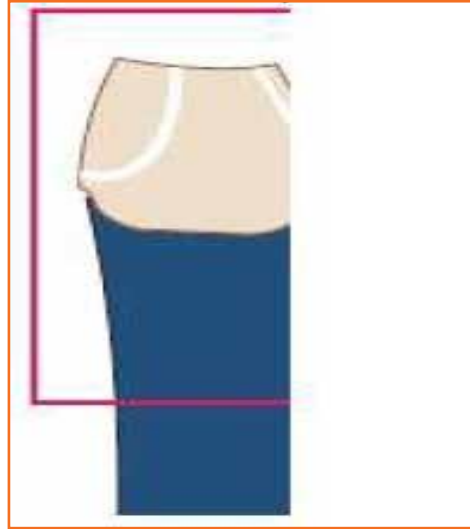

Step 2: Take the pocket bag and place it over the left front piece aligning with the mouth of the pocket.

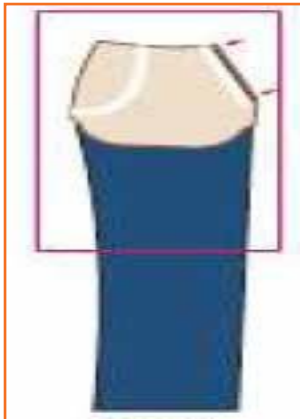

Step 3: Put 6 mm stitch taking $\frac{1}{4}$ line on throat plate as guide, starting from the top to bottom.



Step 4: Turn the piece and put 4 mm stitch at the mouth of the pocket.

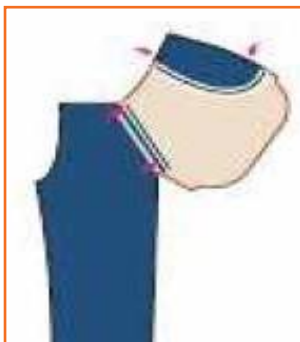

Step 5: Match the lower facing and upper facing at the notch marks.



Step 6: Put 2 mm stitch starting from the waistline to the outer side of the left front piece.



Step 7: Put 5 thread overlock stitches on the curved portion of the pocket bag.

Step 8: Take the other pocket bag and place it over the right front piece aligning with the pocket bag (face to face).

Step 9: Repeat steps 3-7 for the right hand side pocket.

2.3.3.3 Pocket Attaching (Back)

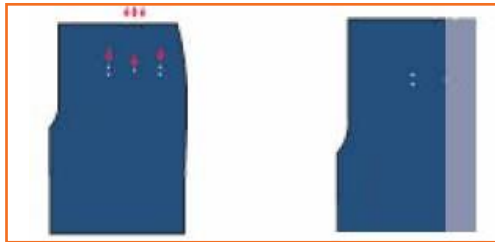

Step 1: Take a note of the notch marks and the pocket marking on the back piece.

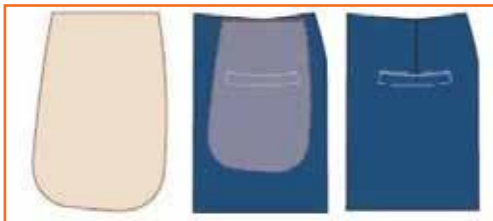

Step 3: Take one of the back pocket bags. Place it below the back piece in such a way that the top end of the back piece and the pocket bag are perfectly aligned. Make sure that pocket bag is aligned centrally to the dart.



Step 2: Fold the fabric at the centre notch mark and make a dart by starting to stitch on the notch mark till the centre marking.

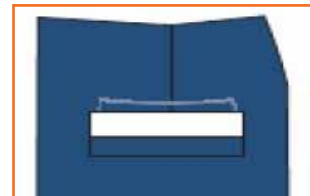

Step 4: Take one of the fused bone pieces and place it over the pocket markings in such a way that the top marks are visible and the bottom marks are covered by the bone pieces and are at equal distance from both sides.

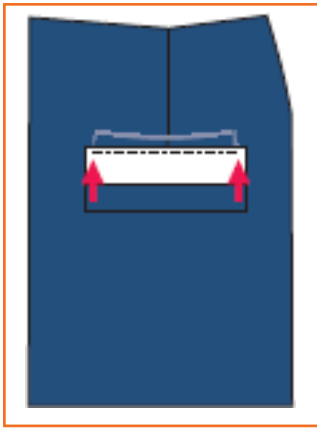

Step 5: Now put a 6 mm stitch starting from back rise side towards the side seam side. The first stitch should be at the notch mark side. Put back tack, both at the beginning and end of the stitch.

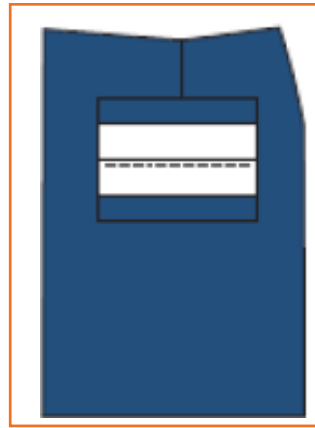

Step 6: Take the second fused bone piece and place it next to the stitched bone piece on the waist side.

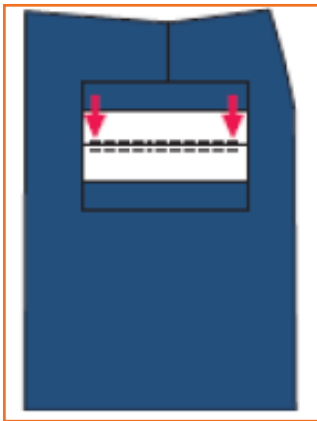

Step 7: Put 6 mm stitch starting from the side-seam side towards the back rise side.

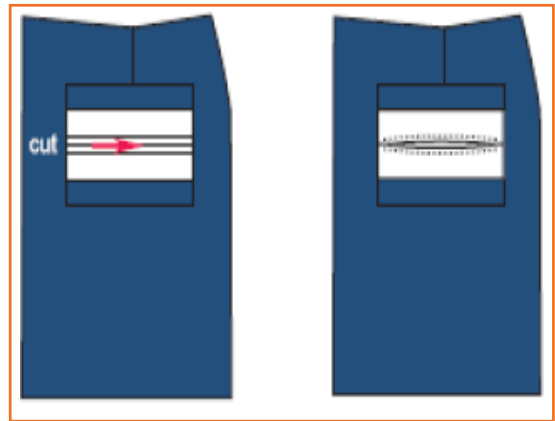

Step 8: Cut the fabric between the two bones leaving 10–12 mm on both sides.

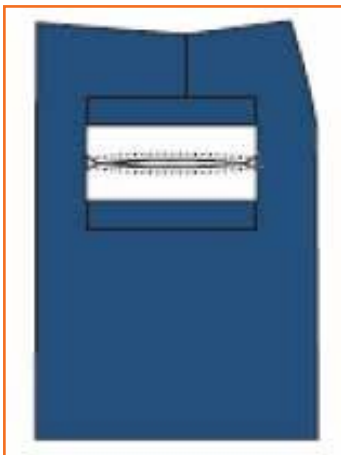

Step 9: Put 6 mm stitch starting from the side-seam side towards the back rise side.

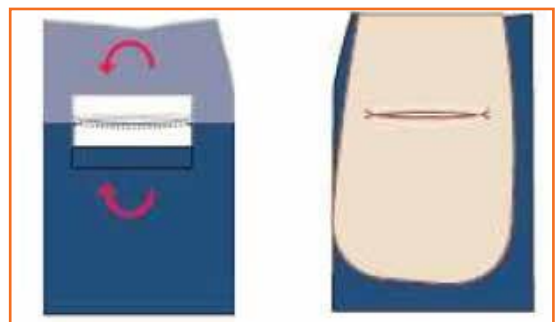

Step 10: Cut the fabric between the two bones leaving 10–12 mm on both sides.



Step 11: Put a stitch on the edge of the folded portion next to the stitched portion.

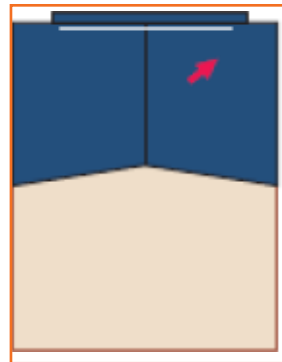

Step 12: Repeat steps 10 and 11 for the other bone.

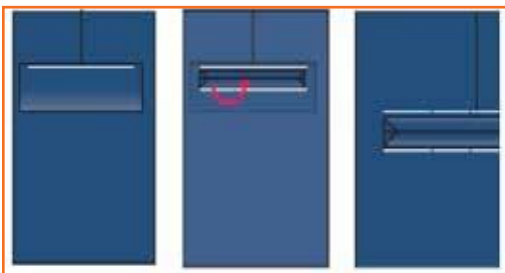

Step 13: Push the balance fabric inside.

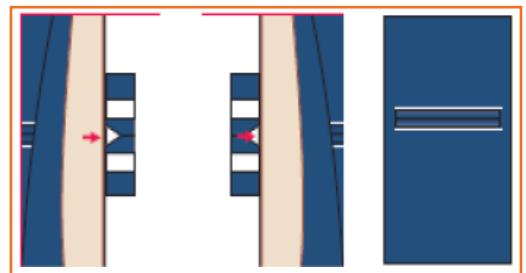

Step 14: Put a stitch at the end of the cut portion.

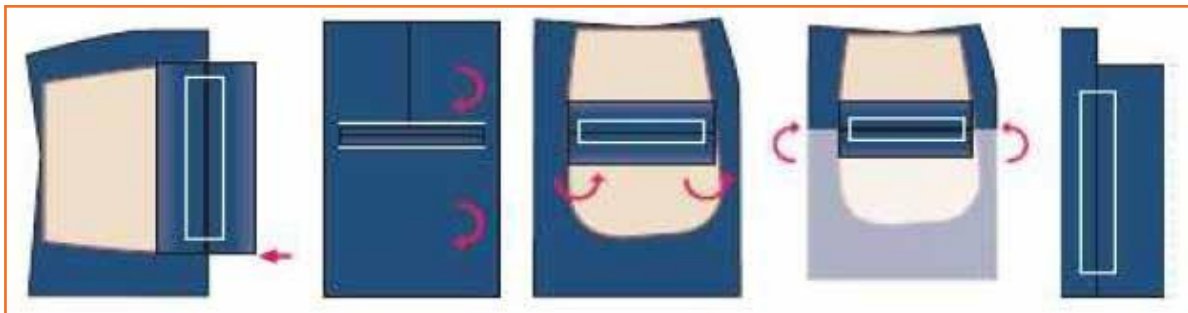

Step 15: Put overlock stitch at the loose end of the bottom bone piece.

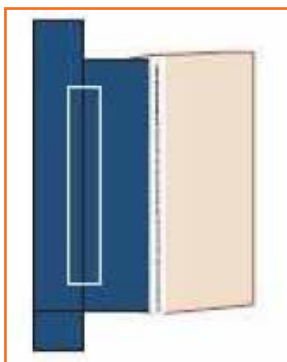

Step 16: Attach bone piece with the pocket bag using lockstitch.

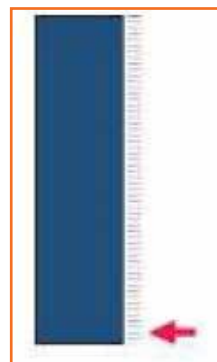

Step 17: Put overlock stitch on the back pocket facing.



Step 18: Take the other piece of the pocket bag. Place the back pocket facing on top of the pocket bag at a distance of 2½ inches from top of the pocket bag.

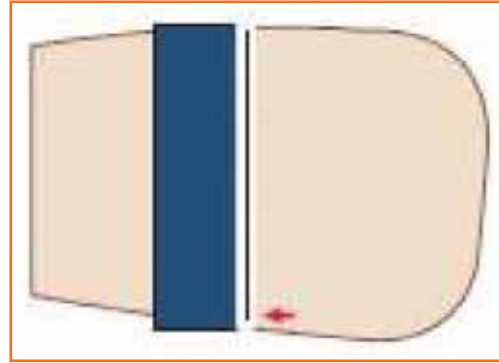

Step 19: Put a lockstitch over the overlock portion.

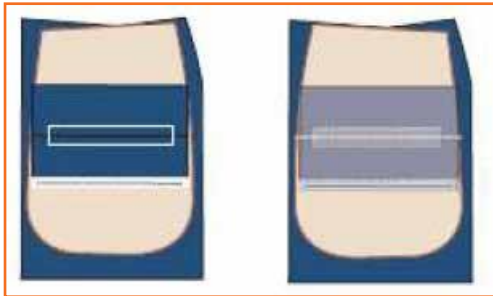

Step 20: Take the first pocket bag, which is already sewn to the back piece. Place the other pocket bag over it. Both the bags should match perfectly.

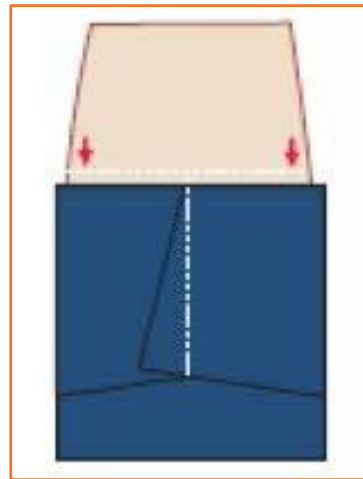

Step 21: Now put a stitch at the inner side to join the two pocket bags together.

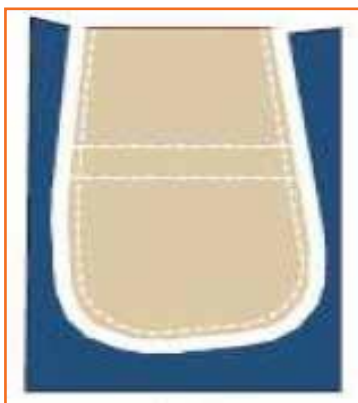

Step 22: Put 5-thread overlock stitches starting from right (back rise side) to the left side.

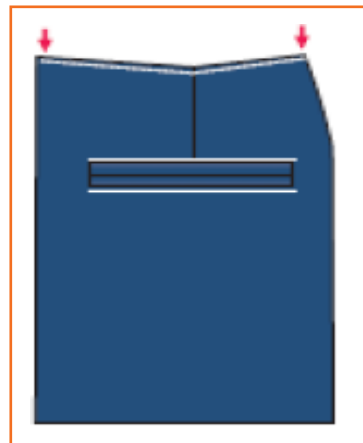

Step 23: Put 3 mm lockstitch at the waistline, starting from the left towards the right, to stitch the loose top end of the pocket bag with the fabric.

2.3.3.4 Fly Making and Attaching

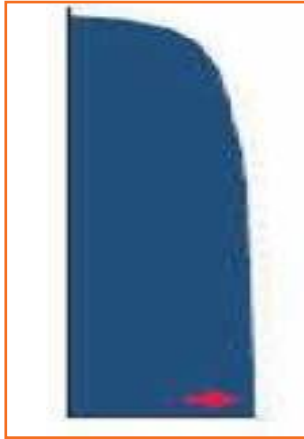

Step 1: Take the fused J-fly piece and put overlock stitch on the face side of the fabric starting from bottom of the curved side till the top.

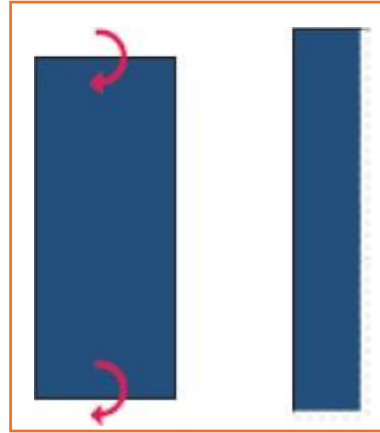

Step 2: Take the fly supportive part. Fold it into two equal parts and put over lock stitch on the long open side and one on the short open sides.

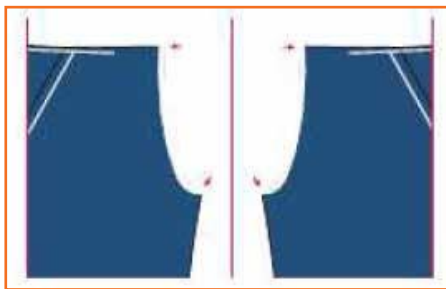

Step 3: Take the fused J-fly piece and put overlock stitch on the face side of the fabric starting from bottom of the curved side till the top.

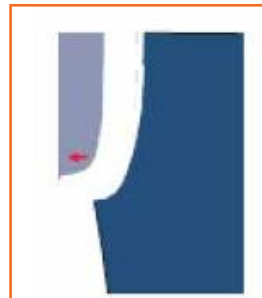

Step 4: Take the left front piece and place the J-fl y piece over the left front piece. Align the straight end of the J-fl y with the front rise along with the backside of the J-fl y facing up.



Step 5: Put a 6 mm lockstitch starting from the bottom to the top (waist line).



Step 6: Turn the J-fl y piece and put an edge stitch on top of the fly from bottom to top. Make sure that the raw edges are facing towards the fly.

2.3.3.5 Zipper Attaching



Step 1: Take the zipper, open it and bring the slider down.



Step 2: Place the zipper with slider facing down over the fly piece at 8 mm from the straight edge at the top and 6 mm at the bottom. Align the bottom edge of the zipper with the curved portion of the fly piece.

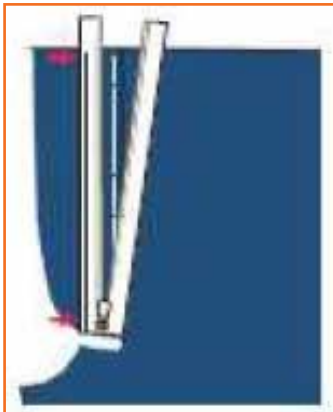

Step 3: Put an edge stitch on the left side of the zipper from top to bottom.

Step 4: Close the zipper and turn the piece 180o clockwise.



Step 5: Now put a 4 mm stitch starting from bottom to top.



Step 6: Take the fly supportive part. Place the zipper with slider facing up on the fly supportive part. Properly align the zipper end and the overlock side of the fly supportive part.

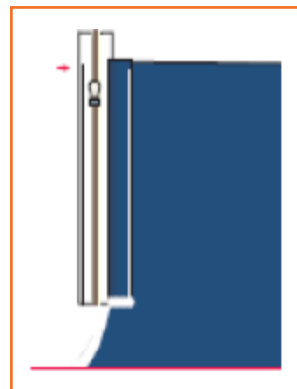

Step 7: Turn the fabric and put edge stitch on the zipper starting from bottom to top.

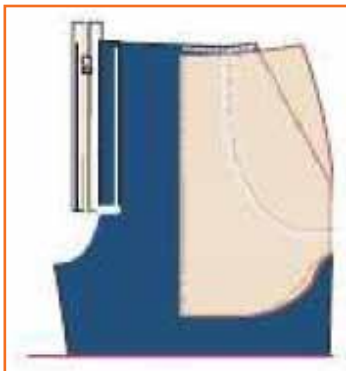

Step 8: Take the right front piece and place the front rise side over the zipper. Make sure that the waistlines of both the left and right front pieces match.



Step 9: Put 6 mm stitch starting from bottom to the top.



Step 10: Turn the stitched panels and bring the face side up.



Step 11: Leave a gap of 1 mm between the zipper teeth and the edge of the fabric and put top-stitch.

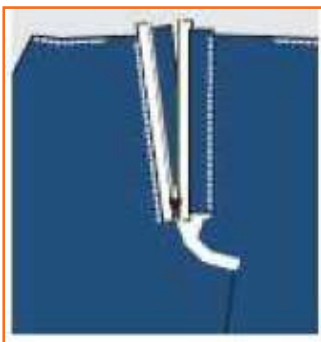

Step 12: Open the zipper.



Step 13: Turn the left side front piece from the zipper side at the point of stitch.



Step 14: Place the ready pattern of J-fly over the left front piece on the front rise side.



Step 15: Put lockstitch along the ready pattern starting from top to the bottom.

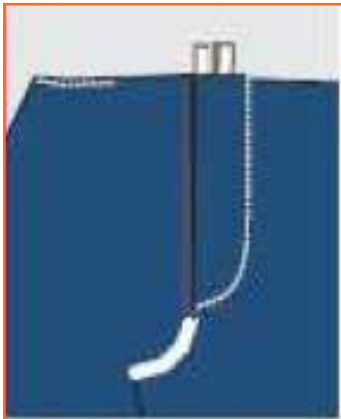

Step 16: Close the zipper and complete the J-stitch along the J-pattern.



Step 17: Put a top-stitch on the edge of the finished J-piece starting from bottom to top.

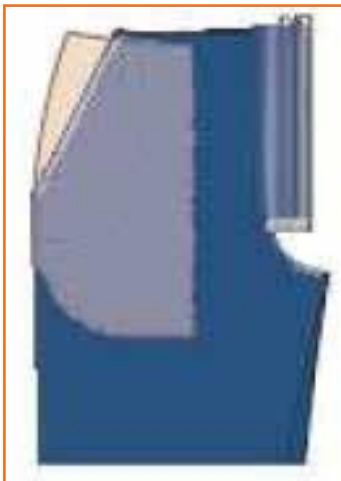

Step 18: Reverse the fabric and put 6 mm stitch on the curved portion of the front rise.



Step 19: Turn the piece so that the front side of the fabric is facing up. Put an edge stitch on front rise starting from bottom till the end of J-stitch.

2.3.3.6 Back Rise Attaching



Step 1: Take both the left and right back pieces. Match them face-to-face.



Step 2: Put 1 cm stitch at the back rise starting from top to bottom with back tack at both the top and bottom.



Step 3: Now put overlock stitches at the back rise starting from top to bottom.

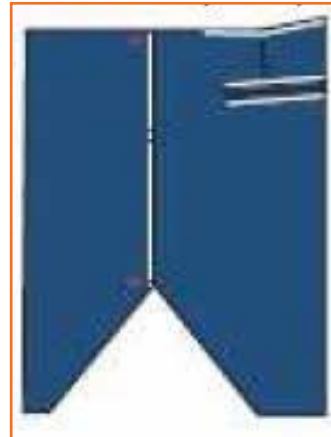

Step 4: Turn the raw edges towards the left side and put top-stitch at the edge of the back rise.

2.3.3.7 Front and Back Piece Attaching



Step 1: Place front and back pieces in such a way that the face sides of both pieces face each other.



Step 2: Put 1 cm stitch throughout the right side starting from top to bottom.



Step 3: Turn the raw edges towards the back. Put topstitches at the edge starting from top to bottom for the right side and bottom to top for the left side.



Step 4: Align the back and front rise seams and the open sides of the front and back.



Step 5: Put 5-thread overlock stitches starting from bottom to finish at other bottom side.

2.3.3.8 Belt Loop Making

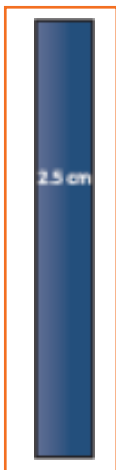

Step 1: Take a long strap, 2.5 mm wide, of the fabric used in body.



Step 2: Turn the raw edges towards the left side and put top-stitch at the edge of the back rise.

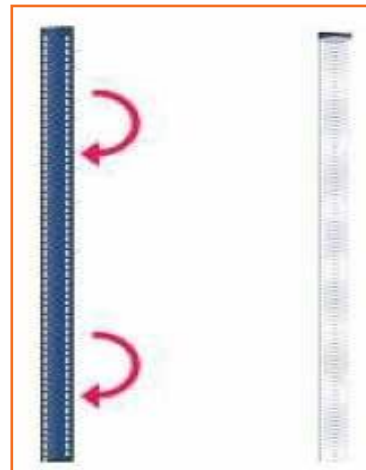

Step 3: Start sewing and feeding the fabric properly.

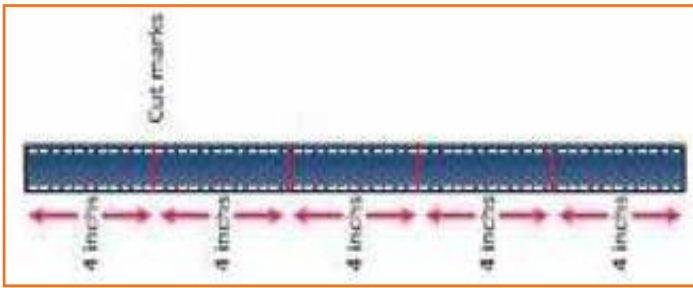

Step 4: Put the marking on the strap for the required length.



Step 5: Cut the strap of desired length.

2.3.3.9 Belt Loop Attaching

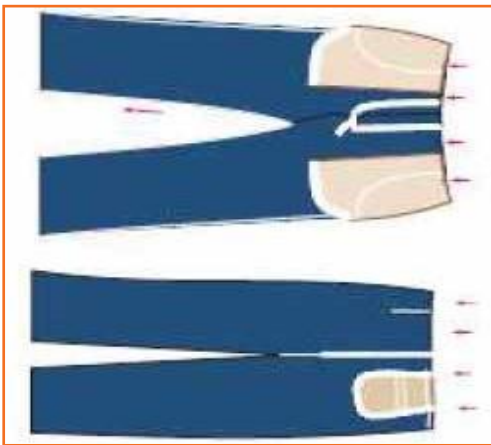

Step 1: Mark the positions on the waistline where the loops are to be attached.



Step 2: Place the belt piece, with the folded side up on the backside of the right front. Belt band should be extended by $\frac{1}{2}$ inch.

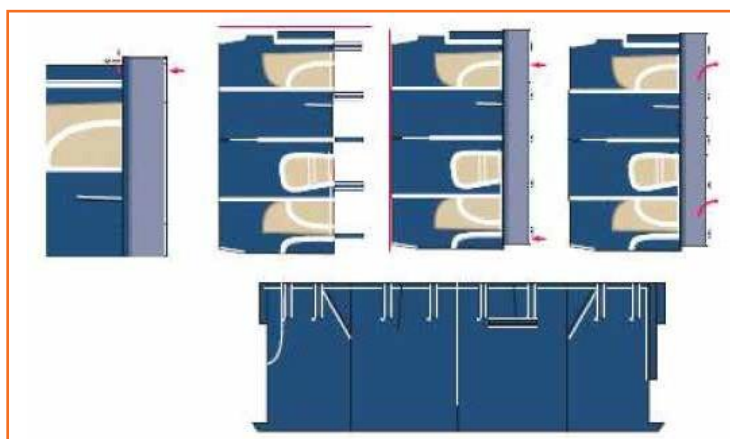

Step 3:

- Put a lockstitch adjacent to the folded part of the belt piece.
- Place the loop with the side facing the fabric and continue to stitch till the end by placing other loops at required positions.

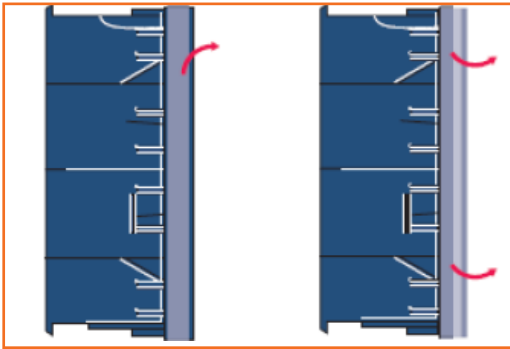

Step 4: Turn the belt piece in such a way that the fused side is up.

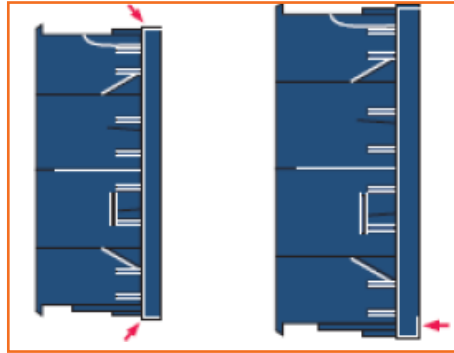

Step 5:

- Stitch the open vertical end on both sides starting with back tack.
- Now again turn the belt piece so that the face side is facing up.

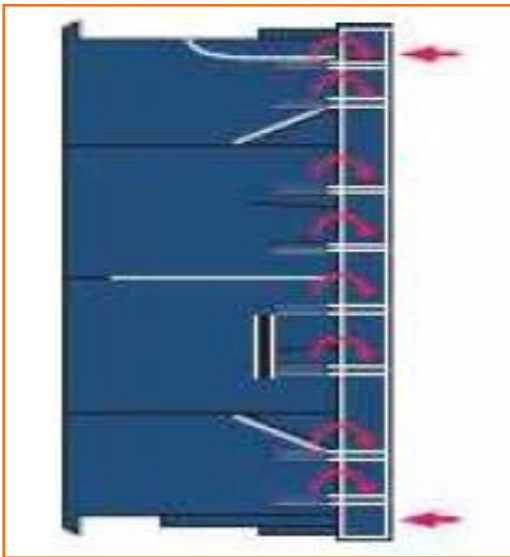

Step 6: Now put edge stitches throughout the length of the belt on the bottom side.

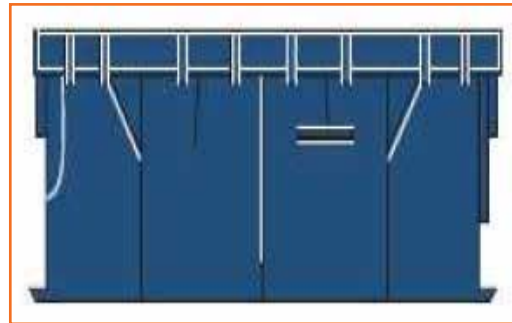

Step 7: Finally put edge stitches throughout the top side of the belt and stitch the loops at appropriate positions.

2.3.3.10 Bottom Hemming

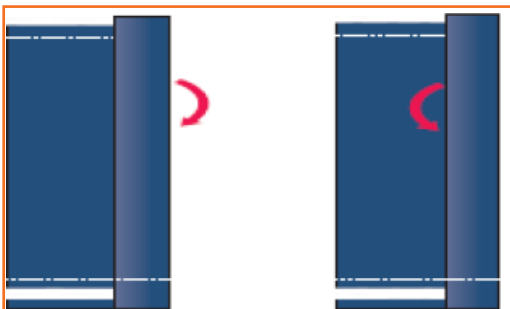

Step 1: Fold the fabric as per the design requirement.

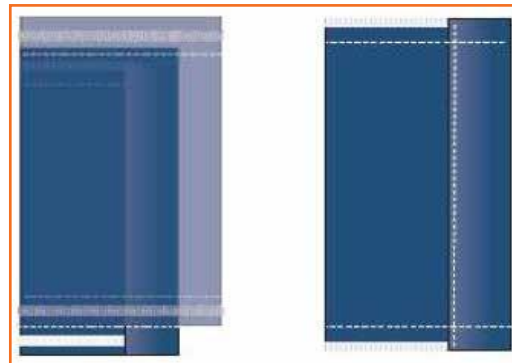

Step 2: Start putting the edge stitch from the inseam and finish at inseam. Repeat steps 1 and 2 for the other leg.

2.3.3.11 Bottom Hemming Using Folder

- Step 1:** Fold the bottom of right trouser leg 1 cm inside. Again fold the fabric to the required width and put 2 or 3 stitches.
- Step 2:** Place the attachment in such a way that the folded portion is fitted into the groove of the folder and then start stitching. Feed the fabric properly.
- Step 3:** Repeat steps 1 and 2 for the other leg.

2.3.3.12 Button Holing

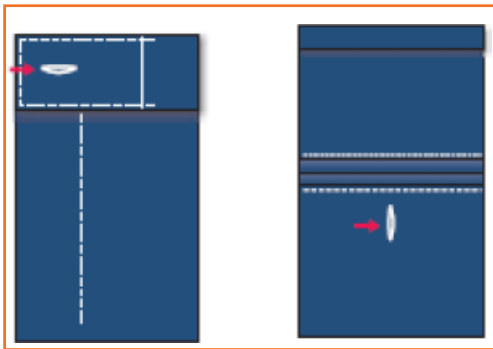

- Step 1:** Make the buttonhole on the left hand side belt as per design requirement. Make another buttonhole on the back pocket.

2.3.3.13 Button Attaching

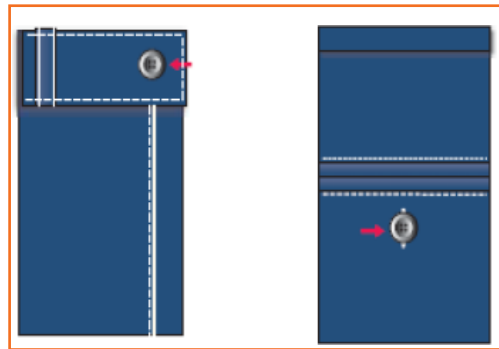

- Step 1:** Sew the button on the right hand side belt as per the design requirement and sew one button at the back pocket.

2.3.3.14 Bartacking

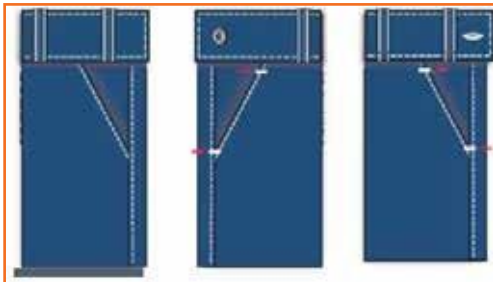

- Step 1:** Put bartack as per design requirement. Normally bartacks are put at both ends of left and right front pocket mouth and at the end of the front and back pocket joints.

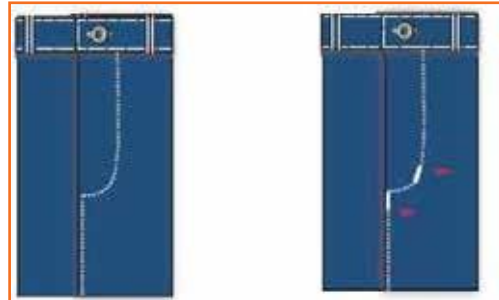

- Step 2:** Put the bartack at the end of the J-fly and at the curve of the J-fly.

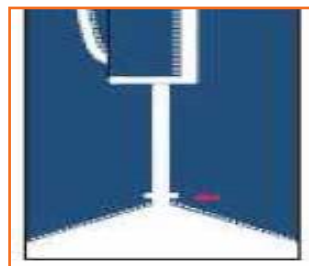

- Step 3:** Put the bartack at the joining of front and back rise.

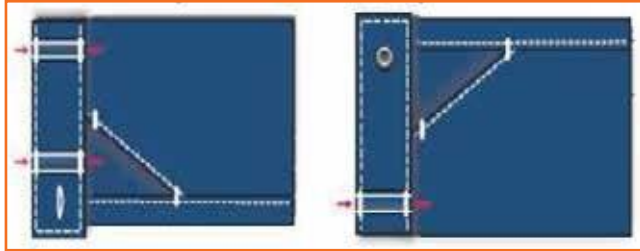

Step 4: Put the bartack at the top and bottom of each belt loop.

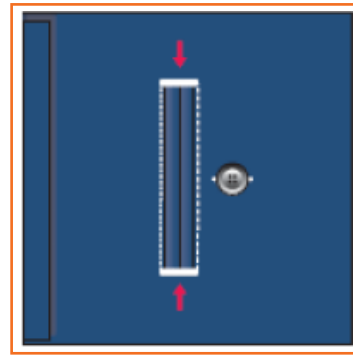

Step 5: Put the bartack at both ends of the back pocket.

Industry Visit

The purpose of visiting an apparel manufacturing unit is to get hands on knowledge about various processes involved in the work of an SMO. During the visit you have to interact with Sewing Machine Operators and supervisors to understand how work is done in industry. Make sure that you keep a notebook handy and note down any important points that come up during your interaction at the apparel manufacturing unit. When you go to an apparel manufacturing unit, you should:

- Recognize the different parts of a trouser.
- Analyze how an SMO makes and attaches the pocket bag, fly, zip, back rise and front and back pieces to pant.
- Also see how he makes and attaches the belt loop, bottom hemming and button and button holes.
- Ask questions to SMOs/supervisors if you have any query.

UNIT 2.4: Stitching a Shirt

Unit Objectives

At the end of this unit, participants will be able to:

1. Recognize the different parts of a shirt.
2. Stitch a shirt.

2.4.1 A Traditional Shirt

Parts of a Shirt

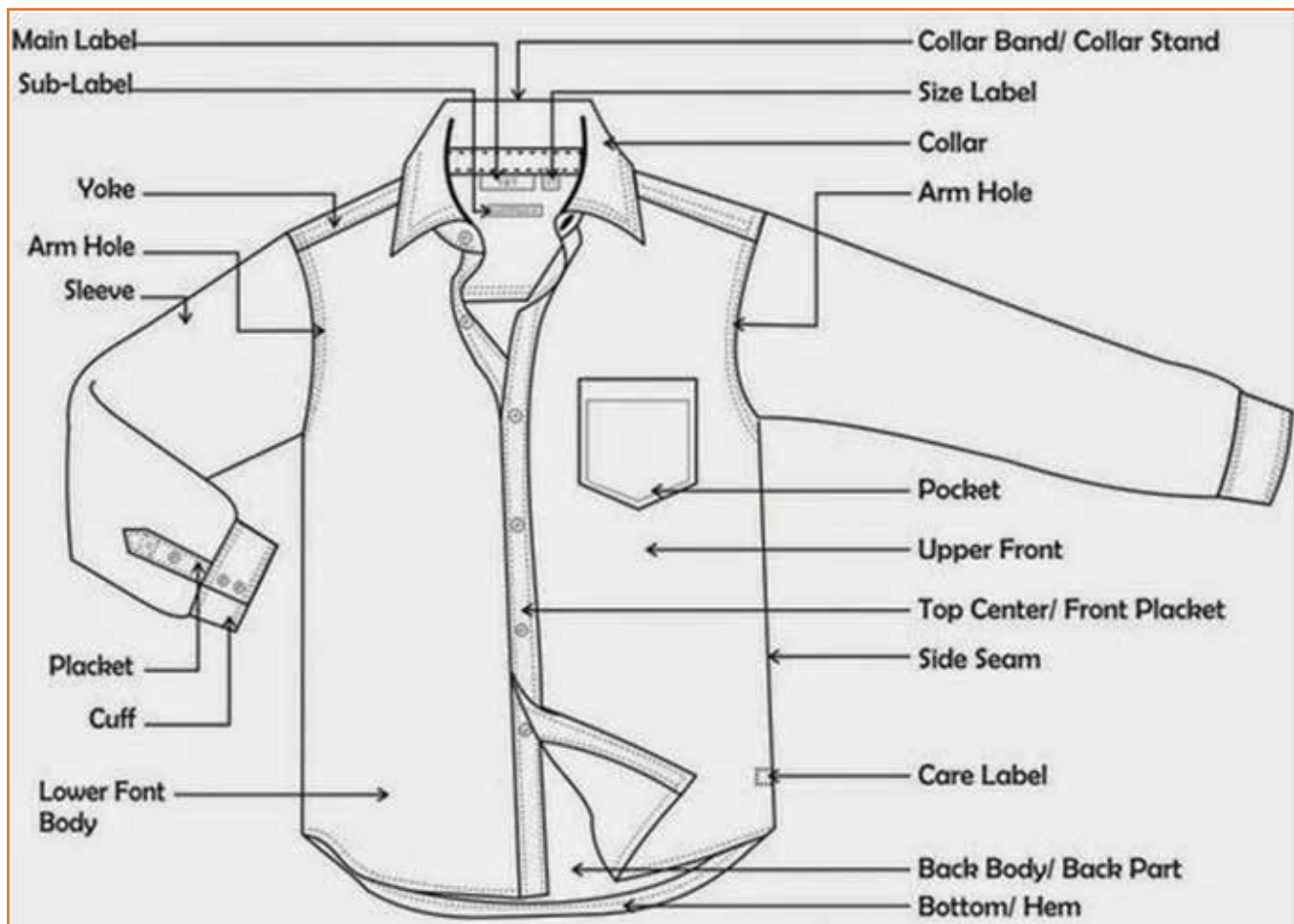
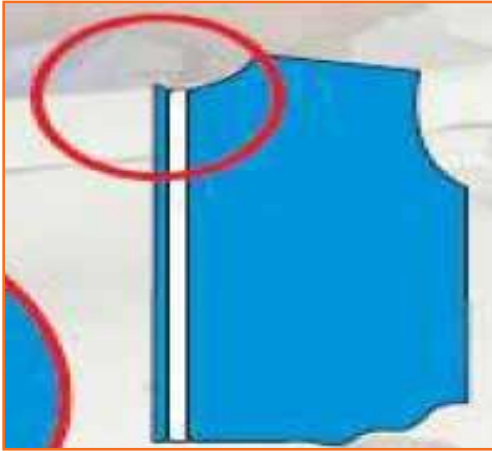
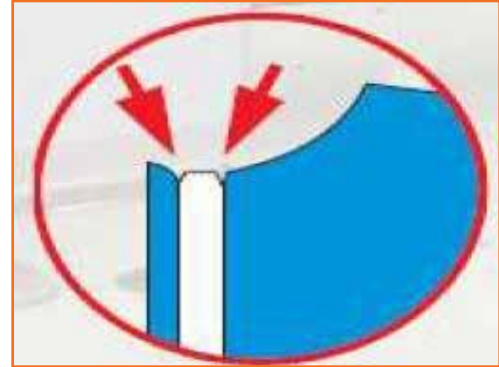

Fig.2.4.1: Parts of a Traditional Shirt

2.4.2 Left Hand Side Placket



Step 1: Take the fused left hand side placket.



Step 2: Locate the two notch marks. There is one at 1.5 cm and the other at 5.5 cm from the edge.

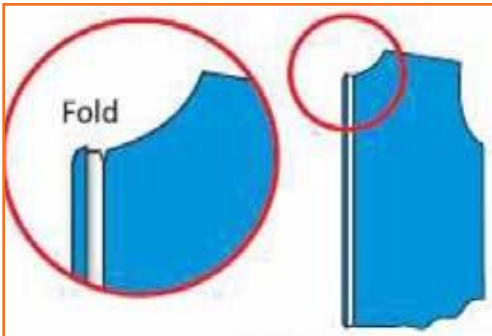

Step 3: Now, fold the fabric 1.5 cm till the first notch mark and press the folded part with an iron.

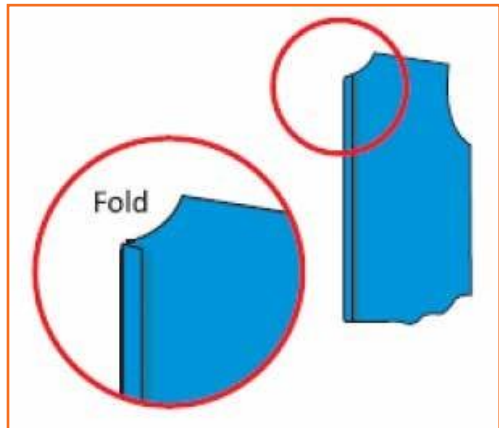

Step 4: Now, fold the fabric 4 cm to the second notch mark. The placket should be 4 cm wide.



Step 5: Now, crease the folded part again with an iron.

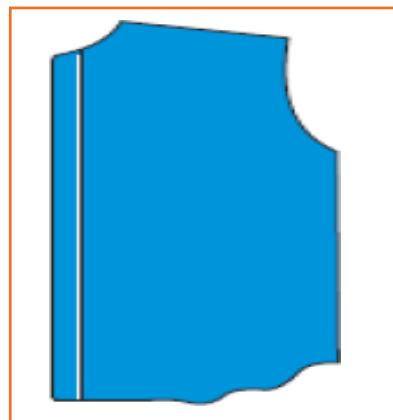

Step 6: Start from the bottom and stitch the inner side of the placket using edge stitch.



Step 7: Again from the bottom, stitch the outer side of the placket using edge stitch.

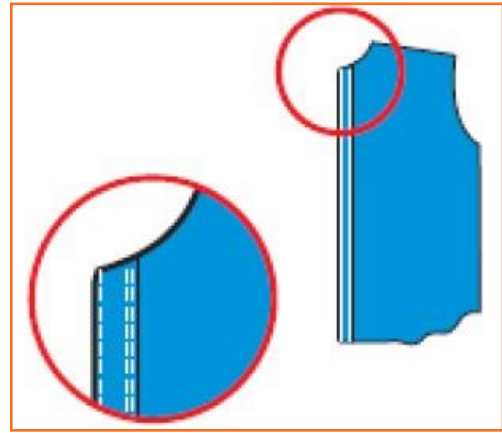

Step 8: Identify the reference mark on the throat plate and put a 4 mm stitch on the outer side of the placket from the bottom.

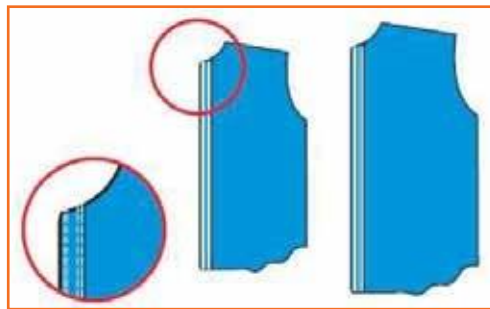

Step 9: Put a 4 mm stitch on the inner side of the placket from the top.

2.4.3 Right Hand Side Placket



Step 1: Identify the notch marks on the back side of the fabric.

Step 2: Fold the fabric 1cm towards the notch mark or the neck, on the back of the fabric.

Step 3: Crease folded part.

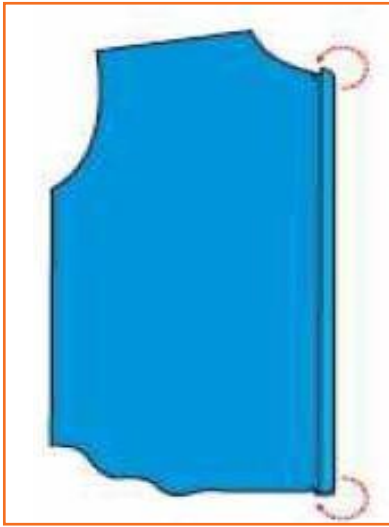

Step 4: Now, fold the fabric 2.5 cm till the second notch mark.

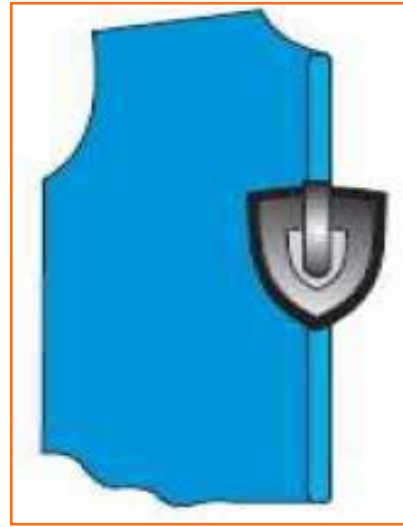

Step 5: Crease the fold with an iron again like in Step 3.

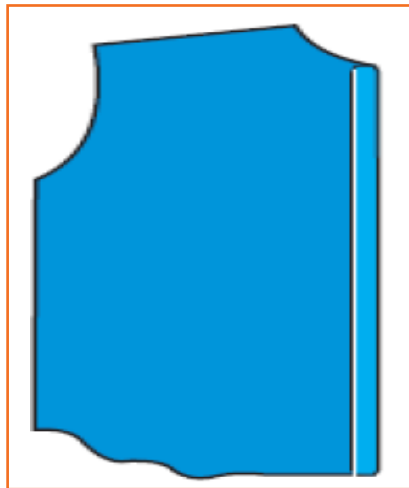

Step 6: Start from the top and stitch the inner side of the placket using an edge stitch.

2.4.4 Pocket Making and Stitching



Step 1: Take the fused pocket piece.

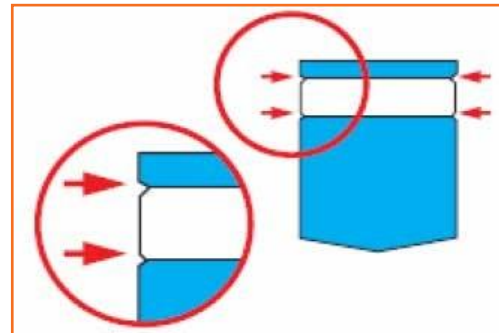

Step 2: Locate the notch marks.



Step 3: Now, fold the top part of the fabric 1cm till the first notch mark and press the folded part with an iron.

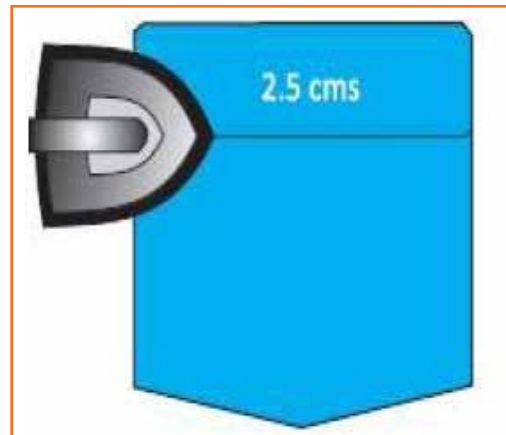

Step 4:

- Now, fold the fabric 2.5 cm to the second notch mark.
- Now, crease the folded part again with an iron.

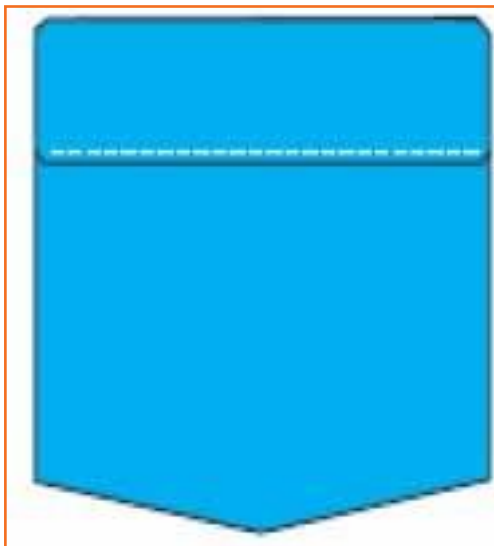

Step 5: Stitch the inner side of the pocket mouth using edge stitch.

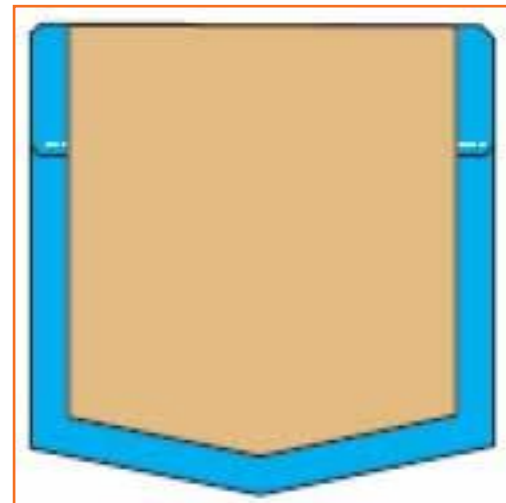

Step 6: Take the ready pattern given and place it over the pocket.



Step 7: Now, fold the three sides 1 cm each and crease them as you fold.

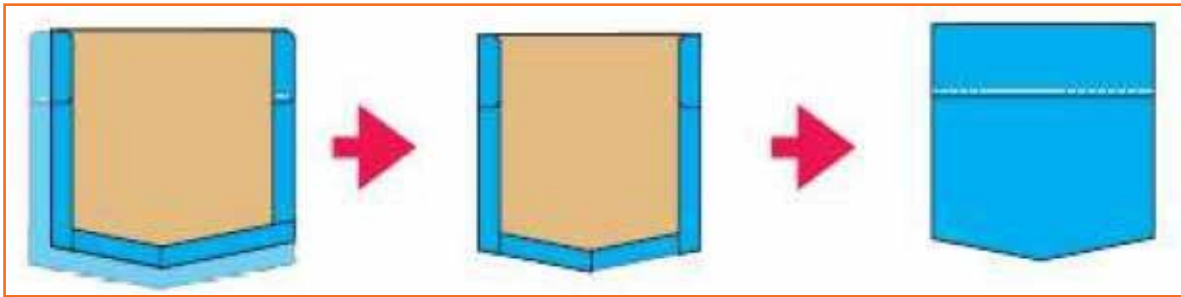

Step 8: The pocket is now ready to be attached.

2.4.5 Attaching the Pocket

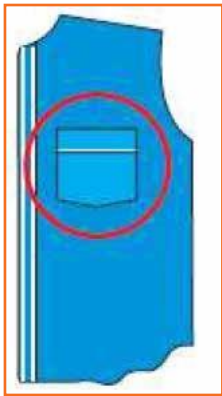

Step 1: Place the pocket piece on the left half of the shirt front.

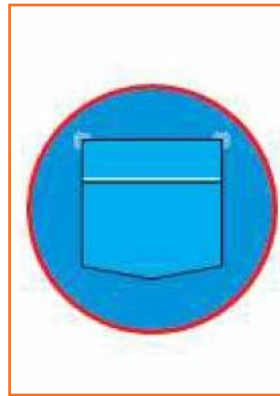

Step 2: Match the right side of the pocket with the markings on the front of the fabric.

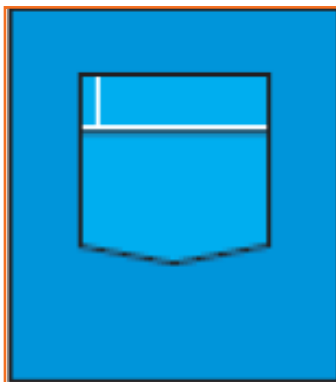

Step 3: Sew the pocket from the placket side. Put 4 stitches followed by a back tack.

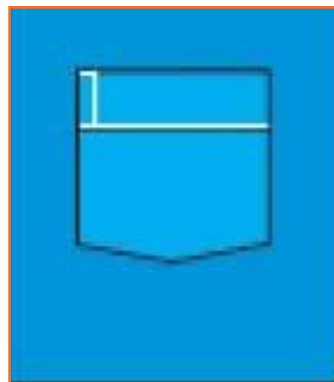

Step 4: Now, sew till the top using 4 mm stitch.

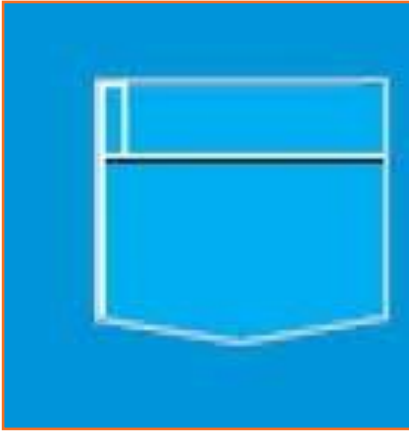

- Step 5:**
- Turn the fabric in a clockwise direction. Keep the needle in the fabric.
 - Stitch at the edge of the pocket till the end.

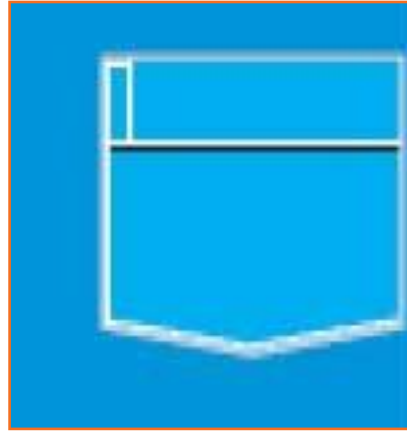

- Step 6:**
- Again, turn the fabric clockwise.
 - Put the stitch at the edge till the end.



- Step 7:**
- Again, turn the fabric clockwise. Stitch the edge of the bottom part of the pocket.
 - Step 10: Turn the fabric clockwise and stitch the edge of the other side of the pocket.

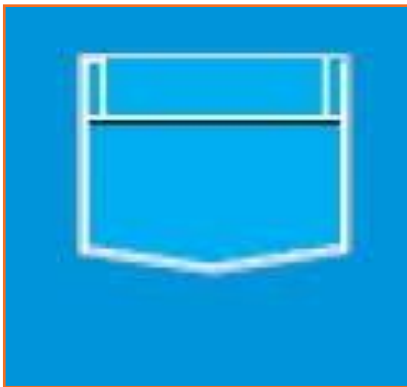

- Step 8:**
- Again, turn the fabric clockwise and stitch up to 4 mm.
 - Turn the fabric. Stitch up to the pocket mouth and put a back tack.

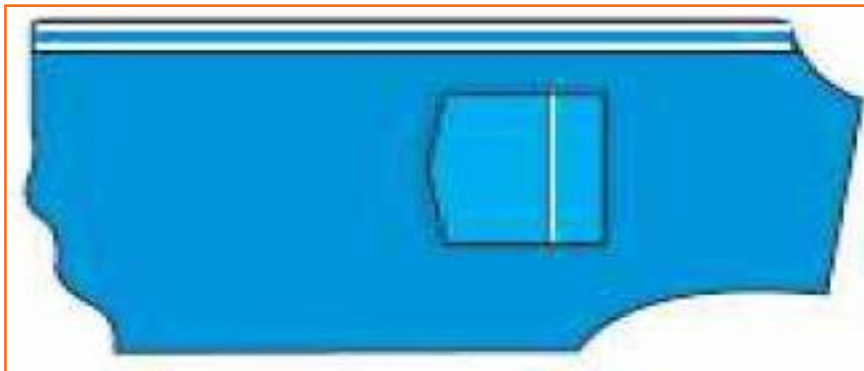

- Step 9:** Now, the pocket is fully attached.

2.4.6 Attaching Yoke

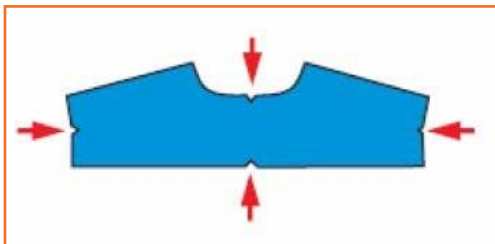

Step 1: First, check for the following notches:

- One notch at the centre of the back piece of the shirt.
- 4 notches in the yoke piece:
 - » One at the centre of the reverse side of the yoke piece.
 - » One at the centre of the neckline.
 - » One at the centre of the left armhole.
 - » One at the centre of the right armhole.

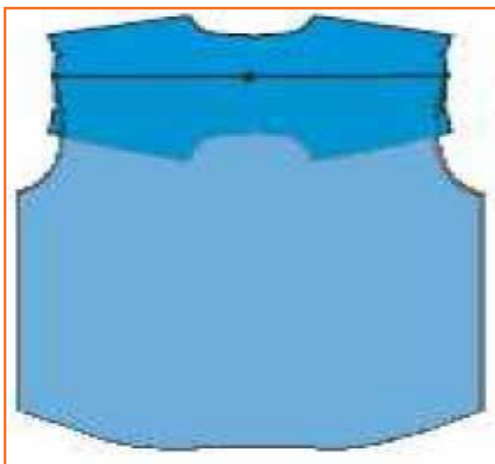

Step 4: The right side of the inner yoke piece should face the reverse side of the back piece of the shirt. Take the other yoke piece and place it on top of the back piece of the shirt and align with the notch.



Step 2: Keep one piece of the yoke on the sewing Fig.

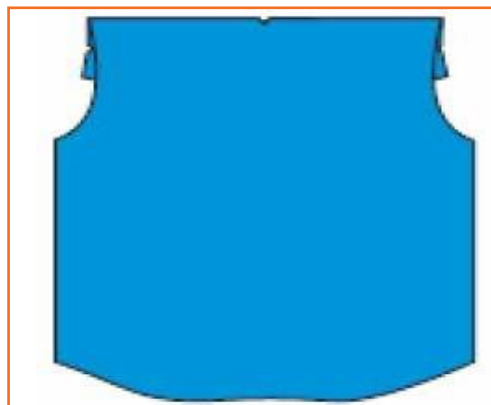

Step 3: Place the back piece of the shirt on top of the yoke in alignment with the two notches.

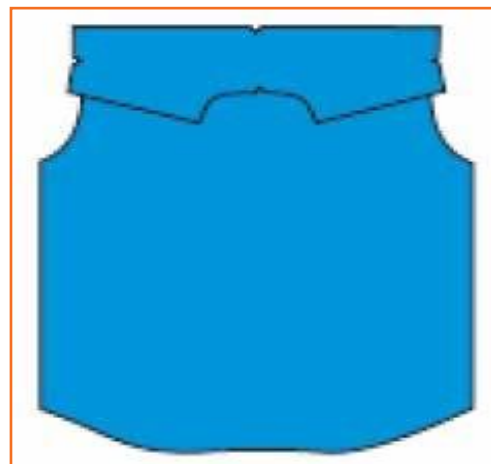

Step 5: The alignment should be such that the right side of the outer yoke piece faces the right side of the back piece of the shirt.



Step 6: Put a stitch of 1cm on the edge of the 3 pieces—2 yoke pieces and the back piece of the shirt.



Step 7: Turn the yoke and crease it with your fingers.



Step 8: Now, put a top-stitch at the edge first.

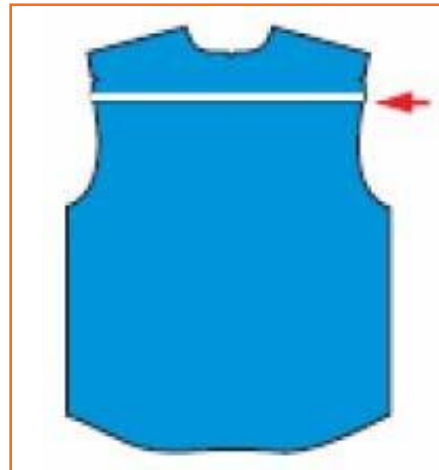

Step 9: Finally, put a 4 mm stitch from the edge.

2.4.7 Attaching Yoke to the Front



Step 1: Keep the front side of the back piece of the shirt on the top.

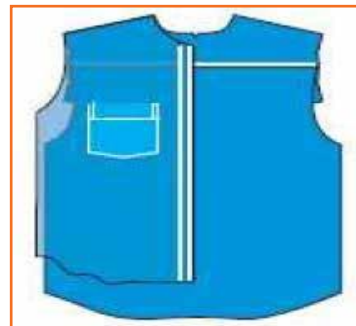

Step 2: The alignment should be such that the right side of the outer yoke piece faces the right side of the back piece of the shirt.



Step 3: The pieces are stitched at a distance of 1 cm from the edge leaving the bottom-most ply of the yoke.



Step 4:

- The right side of the front and the right side of the back piece of the shirt are placed together by matching the yoke. The placket should be towards the centre.
- Repeat Step 3 for right side.

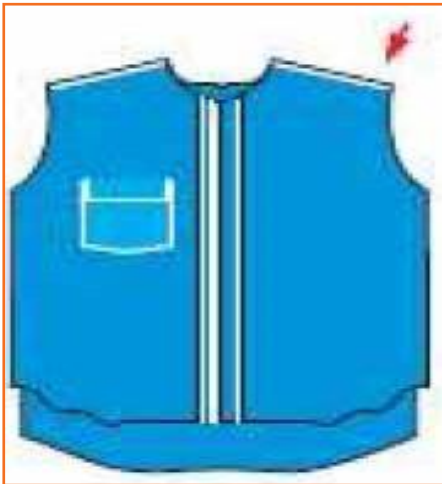

Step 5: Hold the edge of the yoke from the armhole side in one hand and the unstitched yoke piece in the other hand.



Step 6: Turn and match the unstitched yoke piece to the stitched yoke piece.



Step 7: Roll the body fabrics and insert it between the two yoke pieces.



Step 8: Put a 1 cm stitch throughout.

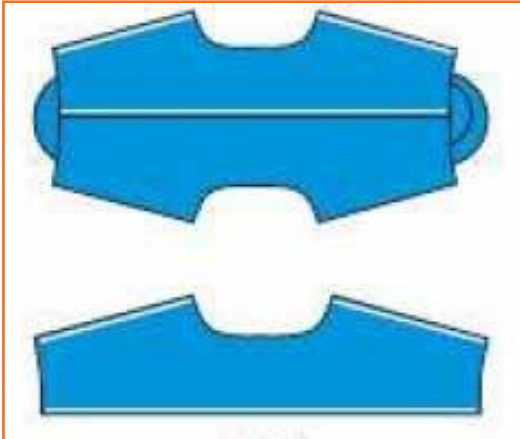

Step 9: Hold the front and the back pieces and stretch them.

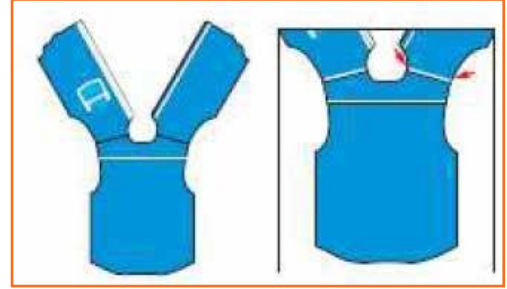

Step 10: Put a top-stitch at the edge on both sides.



Step 11: Finally, put a 4 mm stitch on both sides.

2.4.8 Upper Sleeve Placket Preparation

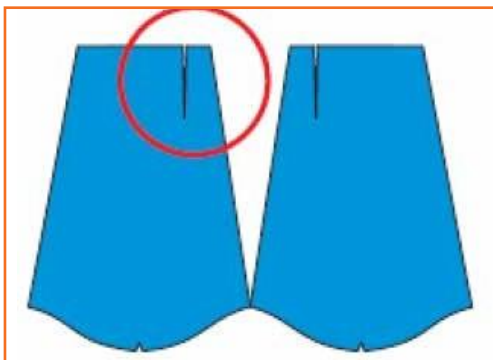

Step 1: Take the two sleeve pieces and identify the notch marks on the armhole side in each one of them.



Step 2: Look at the reverse side of the sleeve and ensure that there is a cut of 13 cms or 5 inches at the bottom.



Step 3: Keep the two sleeve plackets with their straight sides facing each other.

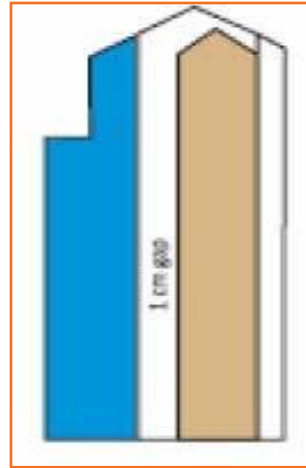

Step 4: Take the ready pattern. Leave a gap of 1 cm and place it over the longer side of the placket.

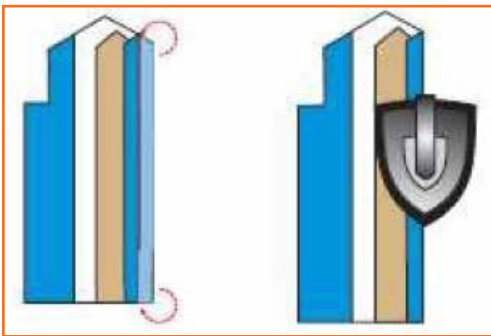

Step 5: Use the pattern and fold the longer side of the placket 1 cm and iron it.

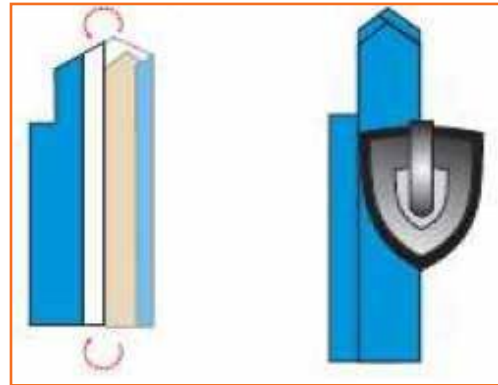

Step 6: Again, using the pattern, fold the longer side 3.5 cm and iron it.

Step 7: Use the pattern and fold the upper portion of the placket in a V-shape. Iron it well to form crease.

Step 8: Use the pattern and fold the upper portion of the placket in a V-shape. Iron it well to form crease.

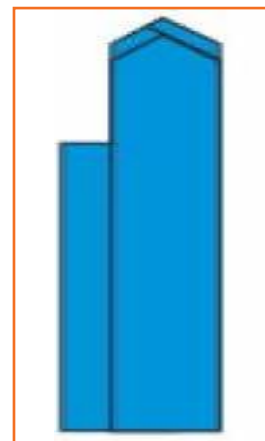

2.4.9 Lower Sleeve Placket Preparation

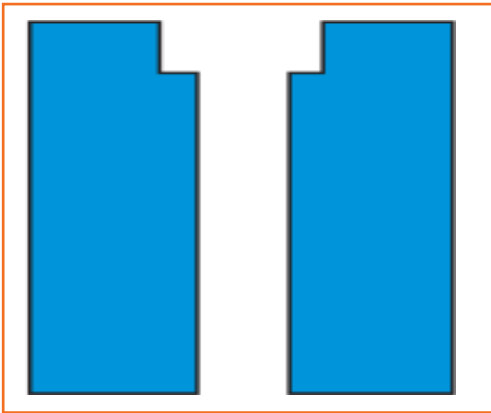

Step 1: Keep both the lower sleeve plackets on the Fig.

They are unfused and shorten in length than upper sleeve plackets.

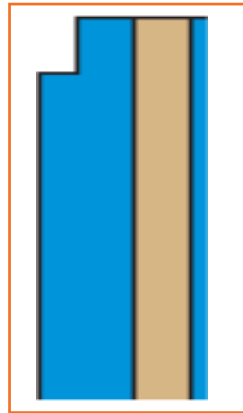

Step 2: Place the ready pattern on the placket.



Step 3: Use the pattern and fold 1 cm. Use the iron to crease it.

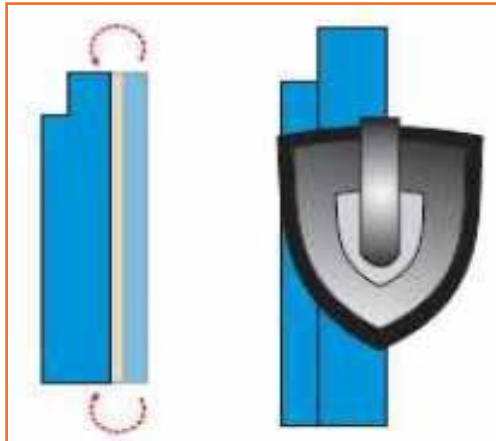

Step 4: Again, use the pattern and fold 2 cm. Use the iron to crease it.

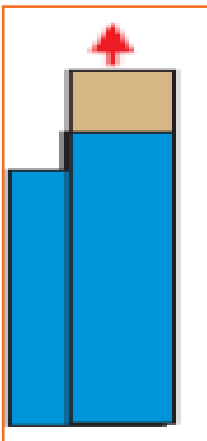

Step 5: Remove the ready pattern.

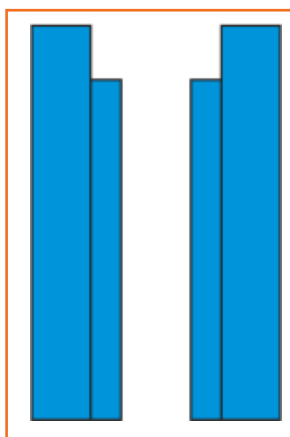

Step 6: Repeat Steps 2 to 5 for the other placket.

2.4.10 Attaching Plackets to the Sleeve

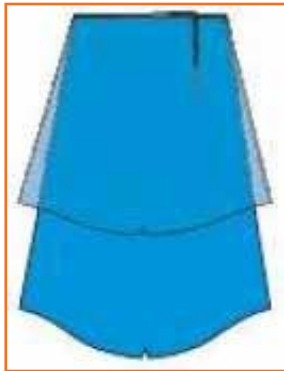

Step 1: Place the two sleeves on top of each other and align the cut sides.

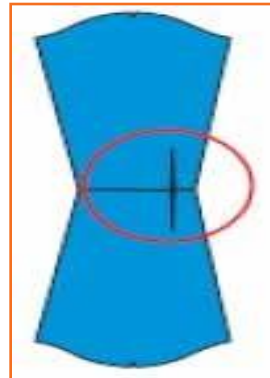

Step 2: Take the two upper sleeve plackets and place them on the longer cut side of the sleeves. Ensure that the folded side is on top.

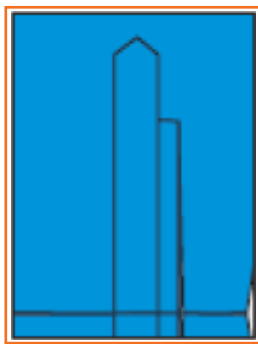

Step 3: Take a set of sleeve placket and sleeve. Align the edges of the sleeve placket with the longer cut part of the sleeve.

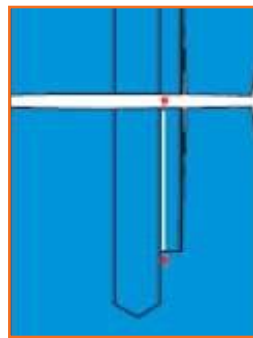

Step 4: Stitch the placket edge. Take the other set of sleeve and sleeve placket. Stitch the placket edge.

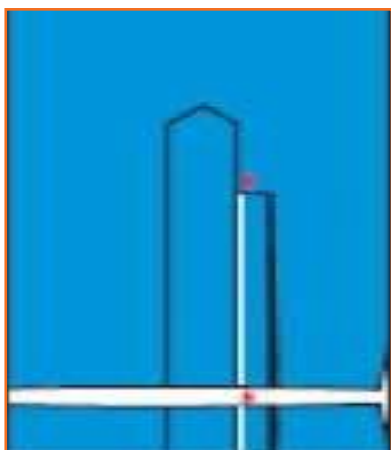

Step 5: Turn the fabric such that the cut part of it faces you.



Step 6: Now, place the lower placket on the shorter cut part of the fabric and stitch the edge along the length. Repeat Step 3 and Step 6 for the other set of sleeve plackets and sleeves.

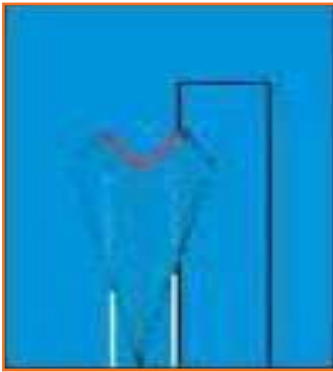

Step 7: Make two v-shape cuts on the top part of the placket-stitch.

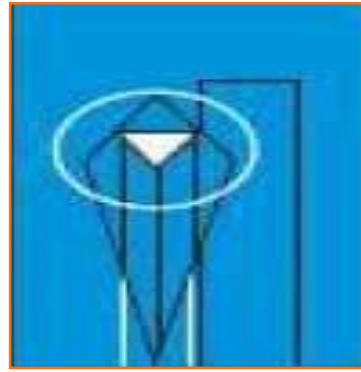

Step 8:

- Smoothen the lower placket and turn it to the reverse side.
- Stitch the edged side of the lower placket till the end.
- Turn the v-shaped cut to the upper side.

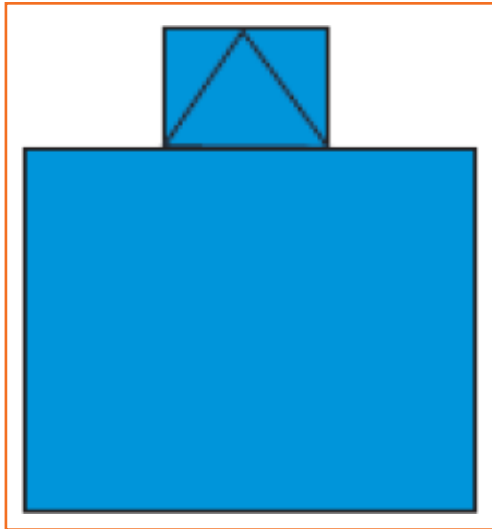

Step 9: Place the placket on top of the v-shaped cut.

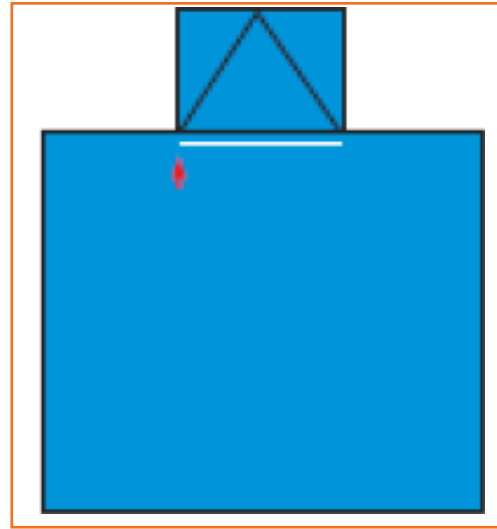

Step 10: Hold the placket and the cut, together and put a stitch at the bottom of the cut.

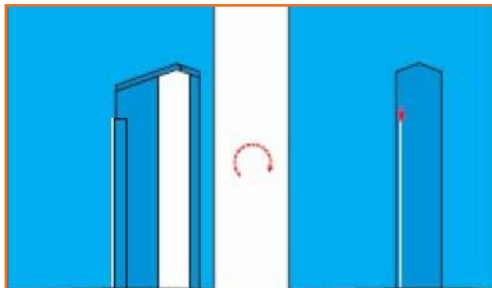

Step 11:

- Turn the upper placket over and put an edged stitch till the end.
- Turn the fabric clockwise. Align the upper and lower plackets.

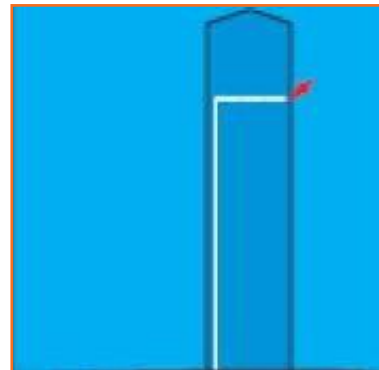

Step 12: Stitch till the end of the plackets.

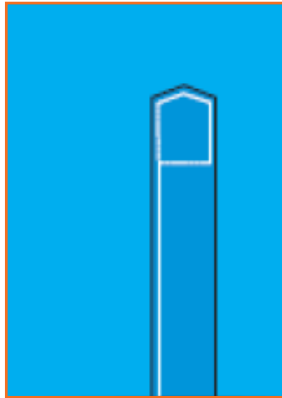

- Step 13:**
- Turn the fabric counter-clockwise. Put an edgestitch on all the edges of the box of the placket.
 - Repeat Step 9 to Steps 7-13 for the other sleeve plackets.

2.4.11 Attaching the Sleeve

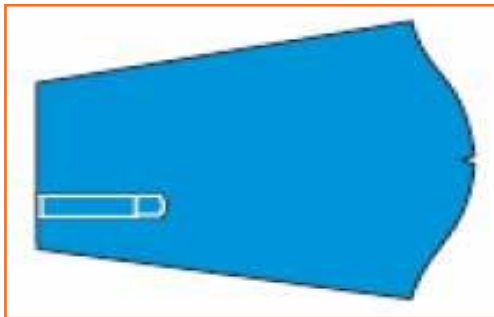

- Step 1:** Take the sleeve piece. Ensure the armhole faces you. Also, the longer cut edge should be on the right hand side. The sleeve should be attached to the left hand side armhole.

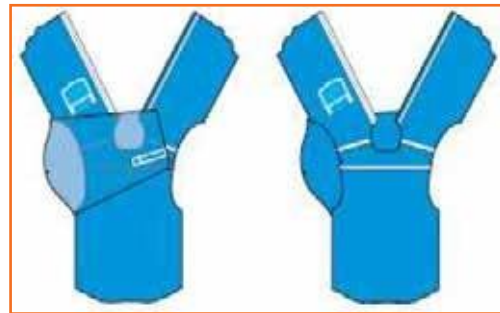

- Step 2:** Match the left front piece with the armhole. Place the shirt front above and the sleeve piece below.



- Step 3:** Attach the left front with the left sleeve with a 1 cm stitch.



- Step 4:** Take the right sleeve and place it on the machine. Ensure that the longer cut portion is to the left and facing away from you.



Step 5: Match the notch marks and attach the sleeve armhole with the body armhole by putting a 1 cm stitch.



Step 6: Put an over-lock stitch at both the armholes. If top-stitch is required on the armhole, the sleeve should be kept up and the body part of the shirt should be kept down while putting the over-lock stitch. In case top-stitch is not required, the body part of the shirt should be kept up and the sleeve down.



Step 7:

- While putting top-stitch, keep the margin towards the body. Put an edge stitch followed by a 4 mm top-stitch.
- Repeat the above steps for the other sleeve piece.

2.4.12 Side Seam

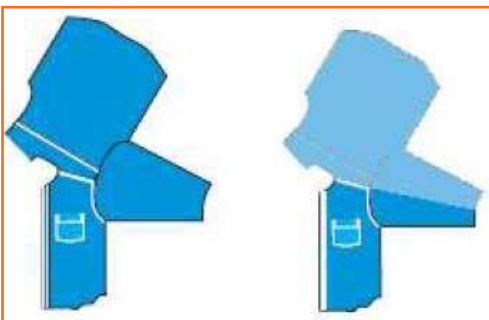

Step 1: Match the armhole and align the loose ends.

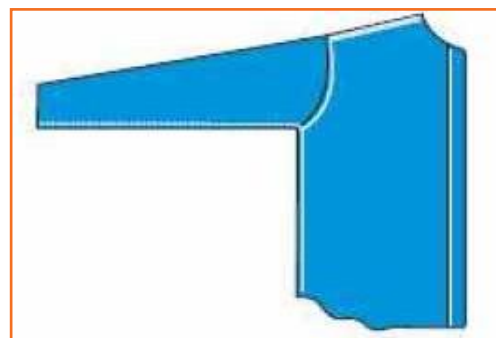

Step 2: Take the right hand sleeve. Stitch 1 cm from the sleeve bottom and continue till side bottom.

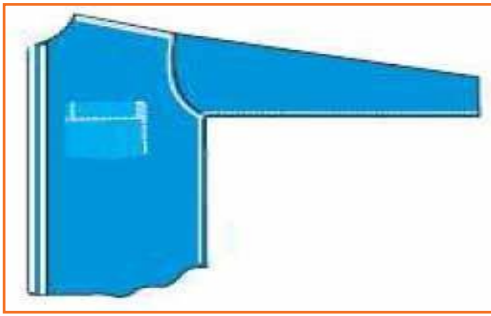

Step 3: Take the left hand sleeve. Stitch 1 cm from the sidebottom up to the sleeve bottom.

- Turn the fabric margin towards back side and sew the top-stitch by first sewing edge stitch and then 4 mm stitches on both the sides.

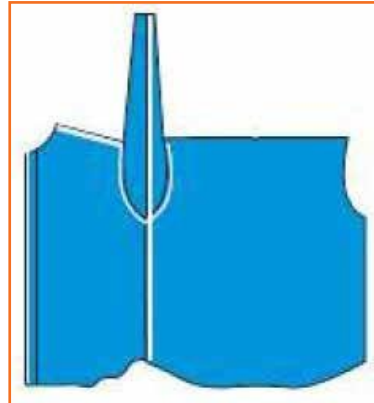

Step 4: • Put the overlock stitch on both sides, keeping the front part on the top.

2.4.13 Collar and Neckband Preparation

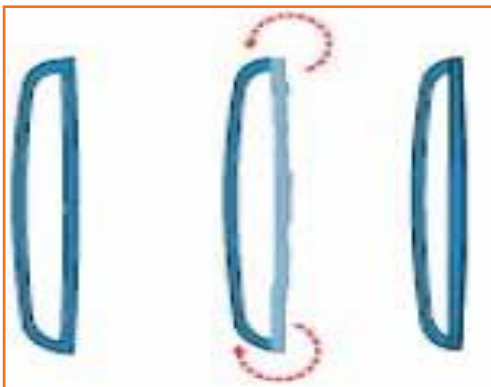

Step 1: Take the fused neckband piece. Turn the bottomend of the piece with your hand.

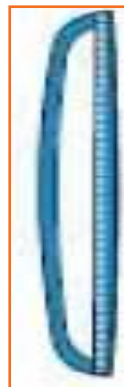

Step 2: Turn the fusing side down. Put a 4 mm stitch at the top.

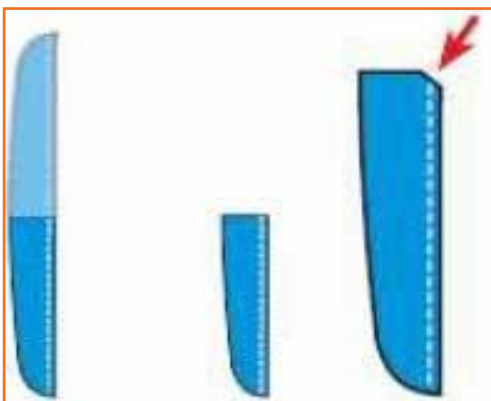

Step 3: Fold the neckband and cut a notch at the centre of the upper side.



Step 4: Take the fused collar piece and place it on the collar piece that is not fused. The right side of the fused collar should face the right side of the unfused collar.

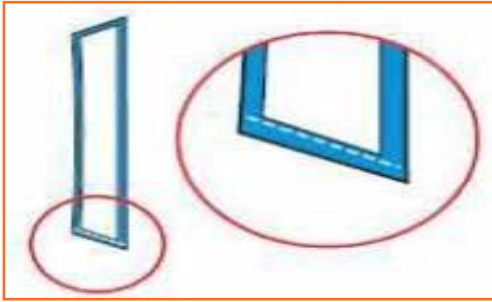

Step 5: Start stitching at a gap of 1 mm from the fusing material from the collar base side.

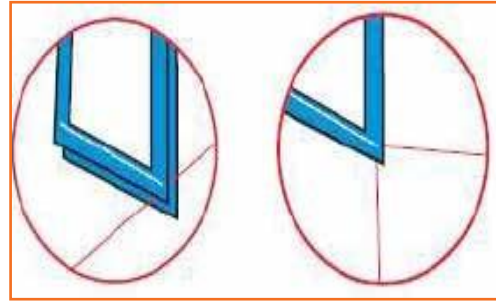

Step 6: Stop the sewing machine one stitch before the collar point with the needle down. Insert an extra thread between the two fabric layers touching the needle.



Step 7:

- Put one stitch and stop the sewing machine with the needle down. The thread will be at the back of the needle side.
- Hold both ends of the thread and bring it towards the other side of the collar.
- Put stitches at a distance of 1mm from the fused material on the remaining collar.
- Repeat steps 6, 7, 8, and 9.



Step 8: Now, put stitches at a distance of 1 mm from the fused material.

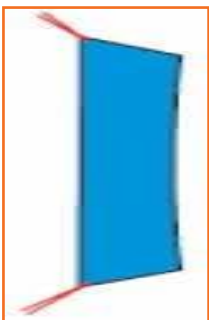

Step 9:

- Put back tack stitch at both the ends.
- Cut both the collar points and turn the collar.
- Stretch the threads to give proper shape to the collar.

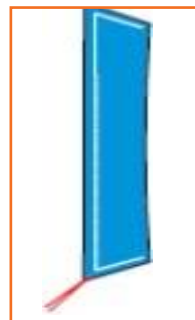

Step 10: Put a 4 mm stitch on all three sides of the collar. Keep the lower fabric stretched to avoid wrinkles.

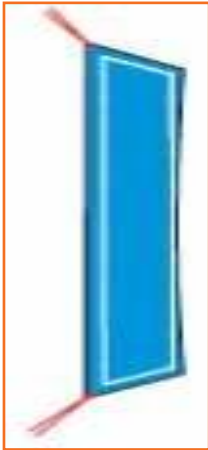

Step 11: Put a 2 mm stitch on the open side of the collar.



Step 12: Put edge stitch on the three sides of the collar.

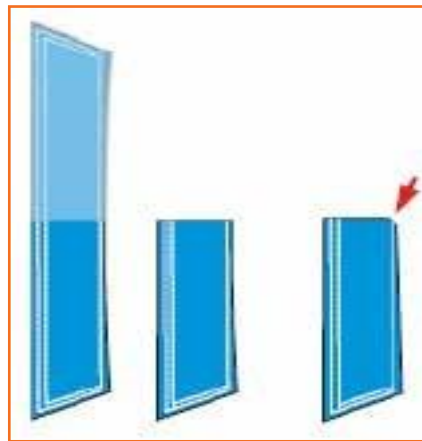

Step 13: Fold the collar and put a notch mark at the centre.

2.4.14 Collar and Neckband Attachment

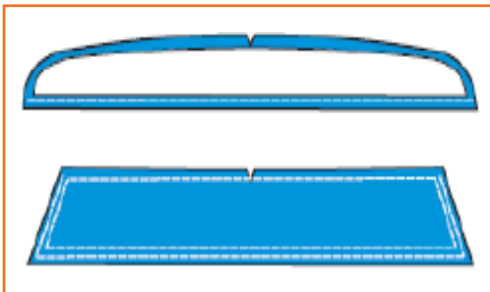

Step 1: Place the neckband and collar face to face.



Step 2: Align the notch and the band of the collar.

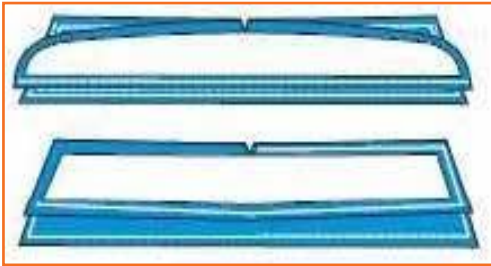

Step 3: Start stitching from the notch point leaving a gap of 1 mm. Repeat this stitch from the notch point to both ends.



Step 4: Take the other neckband piece without fusing. Place it below the ready neckband collar piece.

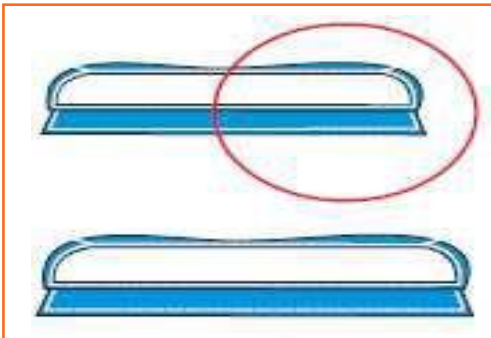

Step 5: Now, start stitching from the neckband bottom portion, till the other end.

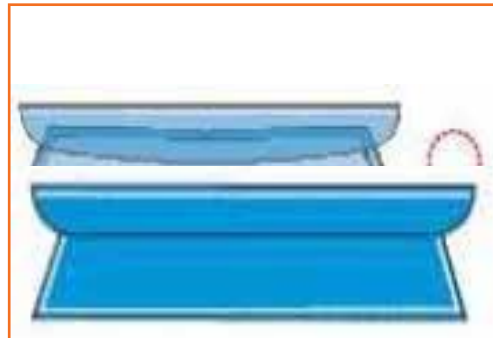

Step 6: Turn the neckband piece.

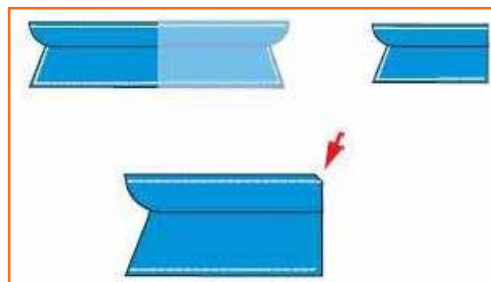

Step 7: Fold the piece and put a notch at the centre. The folded part is now refolded and another notch is put.

2.4.15 Collar Attachment to Body

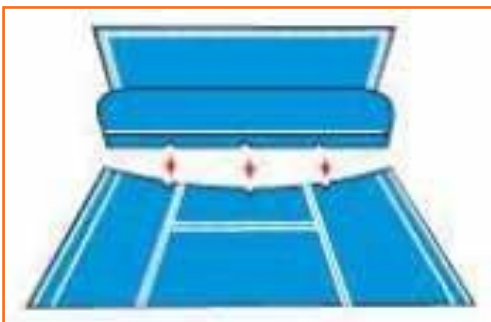

Step 1: Match the three notches on the neckband with the two shoulder seams of the body and the centre notch.



Step 2: Keep the left hand side with face up on the Fig. Match the edge of the front placket with the edge of the collar band.

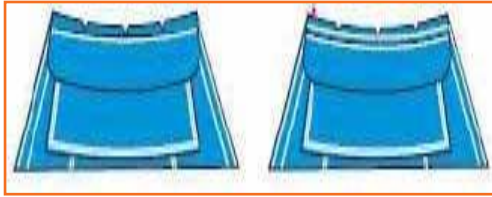

Step 3: Put the stitch just below the fused portion of the band till the end.



Step 4: Starting from the neckband's centre, put edge stitch towards the right side.



Step 5: Turn and continue to put edge stitch till the other end.

2.4.16 Cuff Preparation

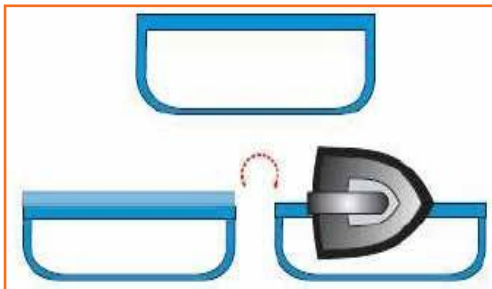

Step 1: Fold the fabric edges on the straight side of the cuff and iron it.

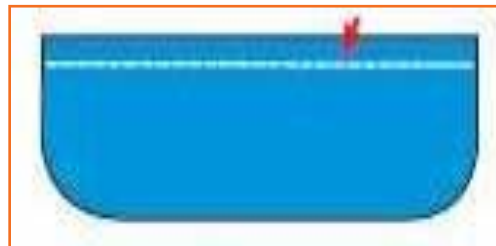

Step 2: Put a 4 mm top-stitch.



Step 3: Take the unfused piece of the cuff and place it below the fused cuff .



Step 4: Stitch the two curved and one straight side by leaving a 1 mm gap.

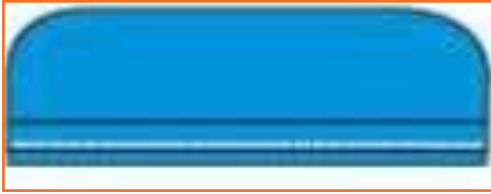

Step 5: Turn the cuff .



Step 6: The unfused cuff fabric should be 1 mm extra.

2.4.17 Cuff Attachment to Sleeve



Step 1: First, check that there are 4 notches for sleeve pleats and one notch at the centre of sleeve bottom.

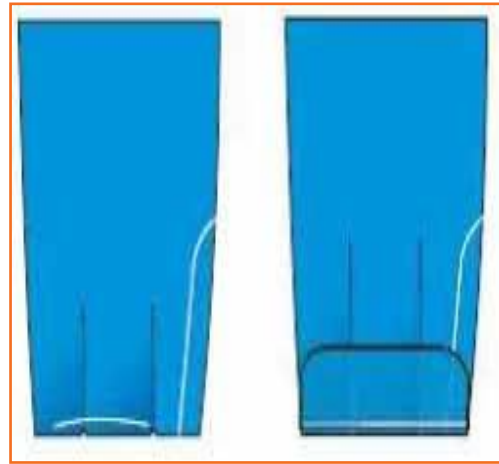

Step 2: Make sleeve pleats by overlapping the notches and stitching it in such a way that the pleats remain open from the edges.

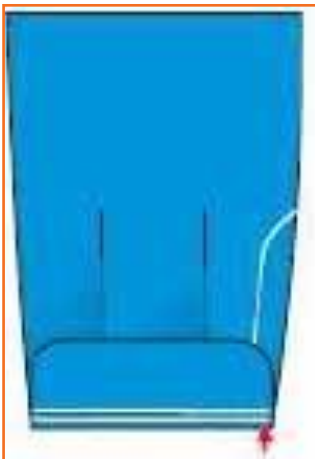

Step 3:

- Place the cuff with fused side up on the inner side of the sleeve.
- Stitch just below the edge of the cuff .



Step 4: Straighten the cuff . Put the excess fabric inside the cuff and put stitches at the edge.



Step 5: Now put the edge stitch throughout the cuff.



Step 6: Now put 4 mm stitch throughout the cuff. Repeat Steps 1 to 7 for the second cuff.

2.4.18 Bottom Hemming



Step 1: Match the collar band tip to bottom.



Step 2:

- Fold the bottom (as per requirement) and put edge stitch from the left front side to the right side.
- Close the two ends.

2.4.19 Button-holing

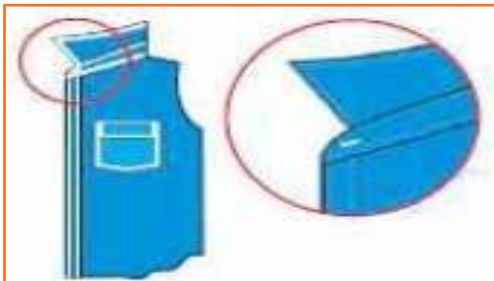

Step 1:

- Take the left hand side placket.
- Make one button hole on collar band parallel to the band at the centre and about 1 cm from the edge.



Step 2:

- Along the centre of the placket width, mark the button holes at a distance of 9 cm from each other from the collar band button hole.
- In case of cuff, mark button hole at the centre of the cuff on upper placket side.
- Make button holes using buttonhole machine. The marking should come in the middle of the buttonhole.

2.4.20 Button Attaching



Step 1: Keep the left hand and right hand plackets on top of each other. They should be properly aligned.

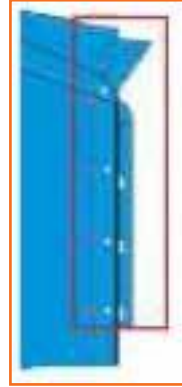

Step 2: Put a mark at the centre of the button-hole using a chalk.



Step 3: Attach buttons at the marked positions using the button sew machine.







Step 4: Repeat the same procedure for the cuff.

Resources



Scan the QR codes or click on the link to watch the related videos.

Descriptions	QR Codes
Tools and equipment used in sewing	 https://youtu.be/_2ZLtGfBJrY
Types of sewing machines	 https://youtu.be/_2ZLtGfBJrY
Parts of a sewing machine	 https://youtu.be/al_hc7DoKXk
Types of stitching	 https://youtu.be/NtmiZU1dkZM
Sewing a pant	 https://youtu.be/Q3Y5Q_iW1Ao

Attaching belt in a pant	 https://youtu.be/7Biev39gR2k
Sewing a shirt	 https://youtu.be/g7AA-gfAKes

Industry Visit

The purpose of visiting an apparel manufacturing unit is to get hands on knowledge about various processes involved in the work of an SMO. During the visit you have to interact with Sewing Machine Operators and supervisors to understand how work is done in industry. Make sure that you keep a notebook handy and note down any important points that come up during your interaction at the apparel manufacturing unit. When you go to an apparel manufacturing unit, you should:

- Recognize the different parts of a shirt.
- Analyze how an SMO makes and attaches the left and right hand side placket, pocket, yoke, placket to sleeve, sleeve, side seam, collar and neckband, cuff and bottom hemming etc.
- Also see how he makes button holes and attaches the buttons to shirt.
- Ask questions to SMOs/supervisors if you have any query.

Exercise

1. Full name of SNLS machine is _____
 - a) Single Needle Latch Step Machine
 - b) Super Needle Lock Step Machine
 - c) Single Needle Lock Stitch Machine
 - d) All the above
2. In SNLS machine thread comes from
 - a) Bobbin
 - b) Hook

- c) Needle
 - d) A & C Both
3. _____ is a flat bed machine ?
- a) Single needle Lock Stitch Machine
 - b) Feed off the Arm Machine
 - c) Overlock Machine
 - d) None of above
4. Feed dogs are used to run_____through machine
- a) Fabric
 - b) Thread
 - c) Both A & B
 - d) None of above
5. Superimpose seam is used for
- a) Neck Finishing
 - b) Pocket attach
 - c) Side seam
 - d) None of above
6. Seam class IV is
- a) French seam
 - b) Flat seam
 - c) Decorative Seam
 - d) Bound Seam
7. Stitch 101 is made by using
- a) 1 Thread
 - b) 2 Threads
 - c) 3 Threads
 - d) 4 Threads
8. Stitch class 300 is
- a) Lock Stitch
 - b) Chain Stitch
 - c) Overdge chain stitch
 - d) None of above

9. Fold the bottom of right trouser leg 1 cm inside. Again fold the fabric to the required width and put 2 or 3 stitches, this is the last step of Bottom Hemming using Folder.
- a) TRUE
 - b) FALSE
10. Patch pocket is a part of a formal trousers ?
- a) TRUE
 - b) FALSE
11. Notches are used to align 2 pieces of garment components
- a) TRUE
 - b) FALSE
12. Which of the followings are the steps of Pocket Making and Stitching:
- a) Locate the notch mark
 - b) Stitch the inner side of the pocket mouth using edge stitch
 - c) Take the ready pattern given and place it over the pocket
 - d) All the above
13. Main lable is stiched on _____ in format shirts ?
- a) Sleeve
 - b) Back Yoke
 - c) Side Seam
 - d) Pocket
14. Feed off the arm machine used to finish _____ of shirts
- a) Cuffs
 - b) Back Yoke
 - c) Side Seam
 - d) Collar
15. In men's shirt right front overlaps the left front
- a) TRUE
 - b) FALSE

3. Contribute to Achieve Product Quality In Stitching Operations



Unit 3.1 - Contribute to Achieve Product Quality in Stitching Operations



Key Learning Outcomes

At the end of this module, participants will be able to:

1. Familiarize with the product quality.
2. Coordinate with seniors and others.
3. Understand the sewing process flow.
4. Learn about the production system.
5. Inspect stitched products against specifications & required quality standards.
6. Identify, mark and place rejects in the designated locations.
7. Carry out alterations.
8. Sew and apply trims by hand and machine.
9. Maintain workflow and meet production target.
10. Familiarize with the quality department and its role in production.
11. Understand the inspection and possible defects.

UNIT 3.1: Contribute to Achieve Product Quality in Stitching Operations

Unit Objectives

At the end of this unit, participants will be able to:

1. Familiarize with the product quality.
2. Coordinate with seniors and others.
3. Understand the sewing process flow.
4. Learn about the production system.
5. Inspect stitched products against specifications & required quality standards.
6. Identify, mark and place rejects in the designated locations.
7. Carry out alterations.
8. Sew and apply trims by hand and machine.
9. Maintain workflow and meet production target.
10. Familiarize with the quality department and its role in production.
11. Understand the inspection and possible defects.

3.1.1 Product Quality

What is quality? If a product fulfills the customer's expectations, the client are happy and consider that the merchandise is acceptable or even prime quality. If his or her expectations are not fulfilled, the client will consider that the merchandise is of low quality. This means that the quality of a product may be outlined as "its ability to fulfill the customer's desires and expectations".

Quality has to be outlined first off in terms of parameters or characteristics, that vary from product to product. For example, for a mechanical or electronic product these are performance, reliability, safety and appearance. For pharmaceutical merchandise, parameters such as physical and chemical characteristics, medicinal impact, toxicity, taste and period of time may be vital. For a food product they will embrace taste, nutritional properties, texture, shelf life and so on.

Fixing product specifications

A specification is the minimum demand according to that a producer or service supplier makes and delivers the product and service to the client. In setting specification limits, the following ought to be considered:

- The user's and/or customer's needs.
- Requirements relating to product safety and health hazards provided for in the statutory and regulatory requirements. Requirements provided for in national and/or international standards.
- The competitor's product specifications, in order to achieve selling advantages.



Fig.3.1.1: Product quality process

- In planning the merchandise, the capability of processes and machines ought to be kept in mind.
- it is additionally necessary to keep up a balance between cost and value realization. The clearer the specification , the higher the possibility of making and delivering quality merchandise. preparing productdesign.
- The specifications and drawings created by the designer should show customary} standard demanded by the client or marketplace in clear and precise terms.
- every dimension ought to have realistic tolerances and alternative performance necessities.
- Product quality ought to have precise limits of acceptability so the production team will manufacture the product strictly per specification and drawings.

To achieve the above, those accountable for design, production and quality ought to be consulted from the sales negotiation stage onwards. the general design of any product is created from several individual characteristics. For example these could be:

- Dimensions, like length, diameter, thickness or space.
- Physical properties, like weight, volume or strength.
- Electrical properties, like resistance, voltage or current.
- Look, like end, color or texture; practical qualities, like output or metric linear unit per liter.
- Effects on service, like style, feel or noise level.

Manufacturing drawings and specifications are prepared by the designers and these ought to illustrate to the production team exactly what quality is needed and what raw materials ought to be used. Preparation for manufacture once the design, together with the producing drawings, has been reviewed and finalized, it is timeto plan for manufacture.

This will include the following steps:

1. **Preferring the strategy of manufacture:** ways should be devised that let the operators and processes to make the merchandise within the fastest, best and most foolproof approach, as well as preparation of producing instructions, putting in procedures, listing numerous operations then on.
2. **Providing the mandatory machines, plant, tooling and alternative equipment:** Everything that's needed for manufacture should be elect, taking care that each one the weather are capable of achieving the quality of quality demanded.
3. **Getting satisfactory raw materials:** nobody will build a decent product from unsatisfactory raw materials,so each material should have a particular written shopping for specification in order that the business department will buy precisely what's needed. typically purchasers ar expected to shop for from suppliers United Nations agency are assessed and approved by them and once provides arrive the products ought to be checked before acceptance into stores. Quality necessities and producing processes ought to be mentioned with the suppliers, also because the inspection activities to be dole out by the client on the products on arrival.
4. **Getting and coaching operators:** Operators United Nations agency ar willing and ready to do the add a satisfactory manner must be chosen and given no matter coaching they have.
5. **Designing review and work quality control:** Plans for review activities ought to be ready, proper work places provided for review employees, written review.

3.1.1.1 Guidelines

A guide for small and medium-sized enterprises procedures ready, inspection instrumentality provided, checking and calibration of examination instrumentality planned for, inspection personnel selected and trained and prepilot and pilot runs carried out. One ought to never conceive to solve a high quality drawback by closing additional inspections.

The producing will begin only if coming up with |the look} and planning are completed. If the look is carried out systematically, things ought to run smoothly. during manufacture the subsequent are the foremost common factors that can affect quality:

- **Set-up:** Some processes, like punching, cutting, printing and labelling, are thus consistent that, if the initial set-up is correct, the entire ton can change to the specifications. However, the initial set-up should be checked by carrying out first-piece inspection.
- **Machines and tools:** From time to time changes will occur in machine or tool settings, which may then causedefects. Processes of this kind include machining, resistance welding and filling. Here it is necessary to carry out periodic checks by patrol inspection.
- **Operator:** There are some processes wherever the result depends on the ability and a focus of the operator, suchas welding, hand fastening and painting processes. For such processes it is necessary at the manufacture planning stage for the operator's operating strategies to be determined upon.
- **Materials and components:** it is vital to ensure the standard of raw materials and components by undertaking regular checks on the suppliers' processes and additionally wherever necessary by carrying out incoming inspection.

The following are obvious possibilities:

- The shop-floor operators had no clear plan what standard of quality was needed.
- the method was such that it was terribly difficult to induce the work right, but very simple to induce it wrong.
- The machine and instrumentality were incapable of achieving the tolerances needed.
- The incoming materials and components were unacceptable.
- The operators were untrained and not up to the job; Shop-floor internal control was either not properlyplanned or not properly executed, or both.

3.1.1.2 Coordination

It is obvious from the on top of steps that everyone in the company, that is, the salesmen, designers, purchasing,stores and strategies employees, plant engineers, jigs and tool personnel, production planning and production employees,operators, inspection and testing employees, packaging, dispatch and so on, square measure answerable for product quality.Indeed, quality is everybody's business. unfortunately, if care is not taken, it winds up being nobody's business.It is so necessary to ensure that everybody is quality-conscious which all of them work along on matters related to quality.

3.1.2 Sewing Department

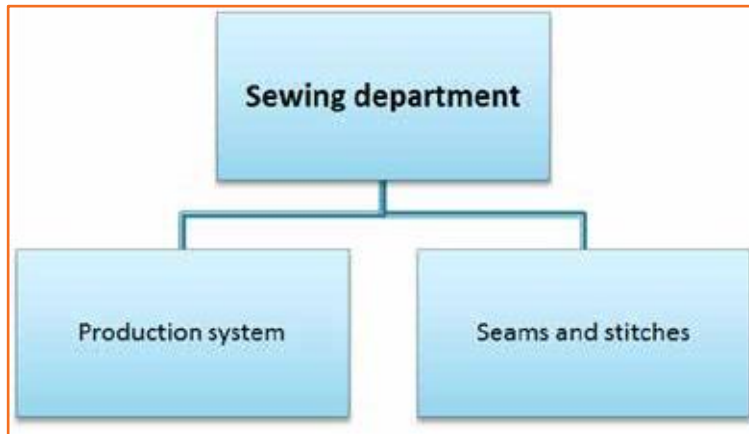

Fig.3.1.2: Sewing Department

3.1.2.1 Sewing Process Flow

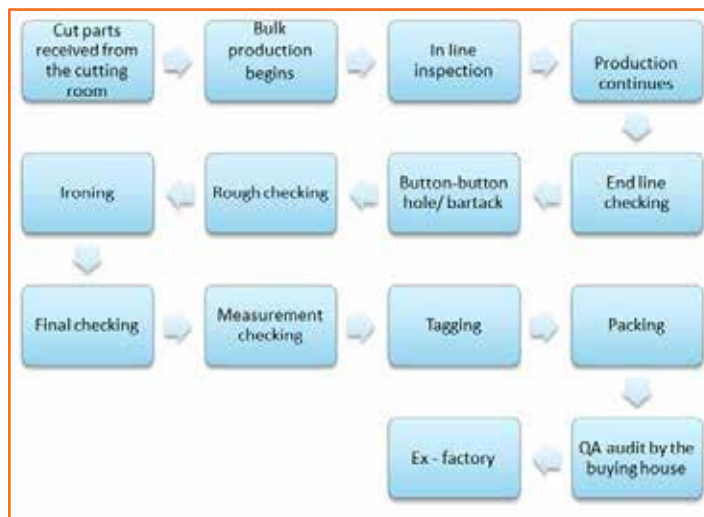

Fig.3.1.3: Sewing process flow

3.1.3 Ensure Stitched Products meet Specification

It is essential to analyse the meet specification in terms of labels and trimmings. There should be various quality check points and before sending the product for final finish it should be thoroughly crosschecked that it has correct labels them. The stitched products should be checked in sewing section and well as printing, labeling or finishing section as well.

Trimmings & labels play an important role in making a good quality garment. Usually trims are randomly inspected. It is usually inspected against standards on the following parameters. Please note that these parameters may differ in other trims.

- **Matching Shade:** It's essential that the trims' color ought to match with base fabric instead of color code or pantone card. Also, the trims those are with Dye to Match demand is checked when attaching trims on the fabric swatch. Check shade of the trims whether or not shade is matched or not. This check is usually needed for shade matching of stitching threads, embroidery threads, etc.
- **Shrinkage:** If the shrinkage percentage of the trims differs from the fabric's (base material) shrinkage percentage, then it is definitely going to cause a defective garment. Trims such as tapes, laces should be tested for its shrinkage percentage.
- **Color bleeding:** bleached trims like Buttons, stitching threads, bleached tapes and laces are checked for color hemorrhage. In this test, trim samples (one by one) are washed with white cloth for variety of cycles as mentioned in testing methods. If the white cloth is got tainted with trims color then these trims should not be used in production. Prior to use, trims should be processed for color fixing to stabilize the colour.
- **Width & Thickness:** live width of the trims such as tapes, elastics, laces etc. it might be good if you're taking measure when wash.
- **Size & Numbers:** Thread numbers, button size, length of zippers etc. need to check against standards.

Labels and tags

Texts printed in the trims for e.g. hang tags, price tags, brand labels, case labels etc. play a vital role. It is very important to make sure that all the information and details must match with the fabric type, the fabric type and the label should not mismatch. Also, the content or text used should be only the one which is approved by the concerned authority. Also, the fibre content printed in care label must match with test report made for fibre content.

3.1.4 Principle of Inspection (Inspection Loop)

Inspection can be defined as the visual examination or review of raw materials, partially finished components of the garments and completely finished garments in relation to some standards, specifications, or requirements, as well as measuring the garments to check if they meet the required measurements.

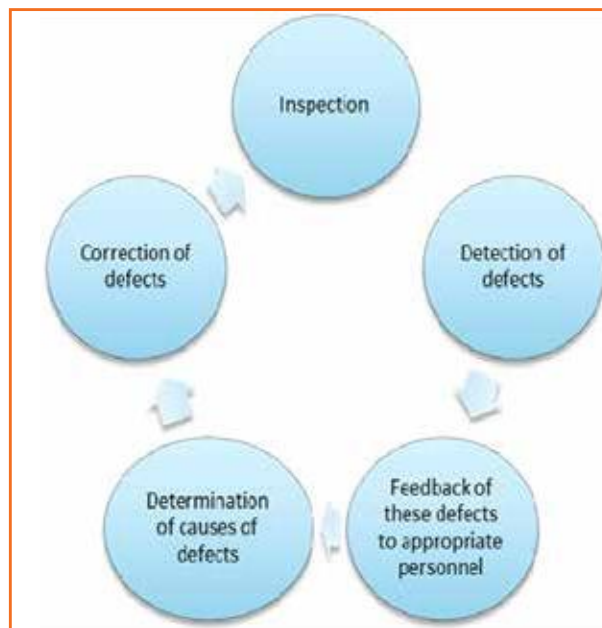

Fig.3.1.4: Inspection Process

How much to examine ?

- No inspection
- 100% inspection
- Spot checking- inspecting random shipments
- capricious sampling-10% sampling
- statistical sampling or acceptance sampling-flexibility with reference to the number of inspection to be performed

Inspection terms

- **Sample:** A sample consists of one or more units of a product drawn from plenty or batch, the units of the sample being chosen at random without regards to their quality. the quantity of units of a product within the sample is the sample size.
- **Lot or batch:** suggests that 'Inspection lot' or 'Inspection Batch', that is a collection of units of a product from that a sample is to be drawn and inspected.
- **Lot or batch size:** The lot or batch size is the number of units of a product in a lot or batch:

$$\text{Percent defective} = \frac{\text{Number of defectives} \times 100}{\text{Number of units inspected}}$$

Make sure to check the garment thoroughly

- There should be no stain like oil stain, or any other stain on the fabric.
- Always assure and check that the finest quality of thread for embroidery (if needed) is used.
- The product should have proper finish, there should be no loose or uneven threads or any other faults should be there in the stitching of the fabric.
- Make sure to look promptly that everything is in the place labels, tags, warning tags, instructions or price tags.
- There shouldn't be any non-conformity in the stitching in context with particular measurements if any, replace the product if it is not matching the given (suggested) dimension or if the fitting is not accurate in context with notches or unmatched seams i.e. armhole, sleeve head or neck band etc.
- Look for any sort of distorted grading .
- Look for any puckering, shrinkage seams.
- Make sure there isn't any shade defect in the stitched fabric, if there isn't the color matching the base fabric then it should be sent for replacement. There should be no skipped stitches, uneven stitches or shrinkage.

3.1.5 Identify Mark and Place Rejects in the Designated Locations

1. Always examine your working surroundings and then the work station where you are working. Inspect if there are any unwanted hazardous materials scattered around your work station or the work area.
2. Keep the work area clean and tidy all the time, once this is accomplished look for any unwanted or faulty item.

3. While looking for a faulty item make sure to identify it properly, mark it clearly and label it promptly as rejected.
4. Always check the raw-materials to identify if there are any signs of discoloration or if there are any other defective signs present in the raw material, if yes label it as reject and take it to the designated location for all rejects and place it there.
5. Place the fabric or other rejected items which are torn, damaged broken, stained etc in the rejection box (designated area) of the work-place.
6. Examine garments at different stages of production for correct positioning of parts appearance.
7. If we talk about garments in particular then it can be said that the garment can be rejected after been tested and declared failed in terms of conformance and specifications
8. Tag items as rejected items so that if possible, they can be reworked on.
9. Items tagged as rejects, should be disposed if they can't be re-worked on.
10. Place the rejected item in the assigned or designated locations only.
11. Always maintain inspection records to compute level of quality control achieved.

3.1.6 Carry out Alterations

Making a product which is of customer's choice and expectations is one of the best ways to run the business or any industry successfully. Hence, it is important to make sure that the material used for making a product should be compatible with that product's specification. Product's accuracy and finishing always depends on what materials are been used on it, what quality fabric is it and are these matching the product's specification or not? This defines the brand.

Make sure to carry out alterations if they are not meeting the specification as per the customer requirements. Many a times alterations are required when the fabric is not been stitched properly i.e. it contains missing stitches also known as skipped stitches or staggered stitches etc. below, some of the common issues discussed where the alterations might be required if they are not meeting the customer's requirements.

Some of the common defects which are found during the stitch are as - Puckering, Seam Grin, Seam Slippage, Skipped Stitches, Unbalanced Stitches, Uneven SPI. After identifying the defects it is important to carry out alterations, without a delay. Reworking on the defects is important however it is more important to understand why the defects occurred, so that it can be avoided in future.

Skipped Stitches: Skipped Stitches are usually caused due to needle defects like bent needle or incorrect sewing tension in the needle or under thread or poor loop formation hence it can be avoided by using a reinforced needle, also make sure to check needle clearance and reset the needle guard. Adjust thread tension to avoid problems occurred due to needle defects.

Staggered Stitches: They are caused when the needle isn't working properly, i.e. if the needle is side-tracked or not sharp enough to work. Or size of the needle & thread are not compatible with one another.

CAUSES	SOLUTIONS
Needle vibrating or deflecting	<ul style="list-style-type: none"> • Increase needle size • Use reinforced needle
Incorrect or blunt needle point	<ul style="list-style-type: none"> • Change needle
Incorrect needle-to-thread size relationship	<ul style="list-style-type: none"> • Change needle thread size to appropriate size

Unbalanced or variable stitches: Incorrect sewing tensions or incorrect threading path can lead to unbalanced or uneven stitches on the cloth. One should check for the right thread path and do the stitching according. Before starting to stitch always check for the needle points, thread and the spring, make sure that everything is set up accurately in its place and then the stitching shall begin.

CAUSES	SOLUTIONS
Incorrect sewing tensions	<ul style="list-style-type: none"> • Adjust top or bottom thread tension as necessary for balanced stitches
Incorrect threading	<ul style="list-style-type: none"> • Check for correct thread path
Variable thread tension	<ul style="list-style-type: none"> • Check for correct thread path • Make sure spring is properly set • Check thread lube consistency

3.1.7 Pass the Stitched Item to the Next Stage after Validation

Once the garment is been stitched and prepared it is necessary to send it further for manufacturing process once it is been validated. Usually, after the garment is been stitched and completely prepared it checked for fabric quality like no loose threads or uneven stitches and labelling (or tags). It is important to have all tags in place i.e. price tag, warranty tag (if any) washing instructions, brand label etc. should all in intact and be at their specific place. The content displayed should be the one approved by the concerned authority, there should be no false statement or mismatch in the language or misprinting. Once they are checked, confirmed and validated then the garment is been sent for the finishing-process of the garment where it is washed, cleaned, pressed. Any activities related to the garment was left un-finished in the previous process i.e. left or missed by any chance it is done at this stage. After finishing it is packed, and distributed to their respective retail stores through the appropriate logistics system and network.

3.1.8 If Stitching Items do not Meet Production Specification

While stitching, many a times there are unwanted and unknown faults which are not good for garments. Hence they are also needed to be rectified so that the garments can be sold or displayed flawlessly. Here are some of the faults which are found while stitching.

Seam Grin: Seam Grin is when two pieces of fabric are pulled at right angles to the seam, a gap is revealed between the two pieces of fabric revealing the thread in this gap. As shown in the image below.



Fig.3.1.5: Seam Grin

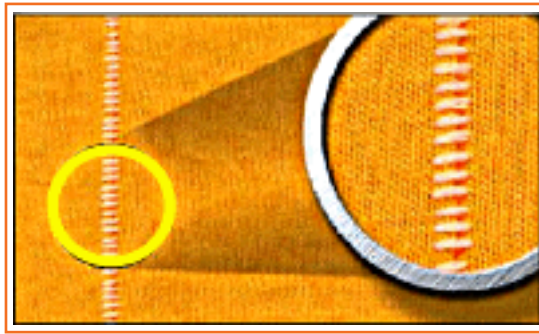

Fig.3.1.6: Seam Slippage

Now as shown in the above picture, there is a gap between the two pieces of fabric however this can be avoided by taking the corrective measures. I.e. if you will increase stitching tensions and use a higher stitch rating seam grin in the garments can be avoided.

Seam Slippage: Seam slippage could be a material connected issue that occurs in fabrics that are with low number of warp and pick yarns. The fabric on either side of the seam distorts as the fabric yarns slide away leading to the permanent gap as shown in the image below. Once you increase seam allowance, use a better stitch density and prefer a lapped fell seam.

Paste your text here and click on "Next" to look at this text rewriter do it's thing. have no text to check? have no text to check? Click "Select Samples".

Seam Pucker:

Bad tension, Bad feet, Fabric, Thread instability

- Uneven shrinkage throughout finishing
- Thread bloat from laundry Structural jamming/ inherit pucker
- Tight weaving doesn't have enough space between yarns for thread
- stitching caused yarns to be pushed out of place

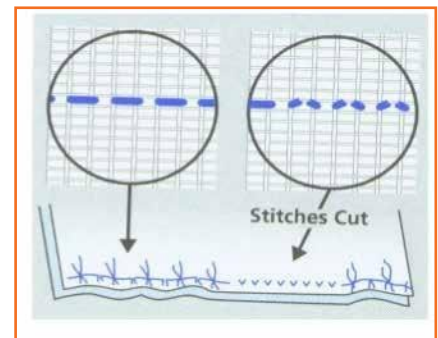

Fig.3.1.7: Seam Pucker

As shown within the pictures on top of, seam pucker usually happens when artificial threads are used. once stitching the threads pass through the stretched state propulsion the material with it. this will be avoided if thread tensions are unbroken.

Feed Pucker: Feed pucker usually takes place while very fine fabrics are sewed. The piles of fabric tend to slip over each other which results in uneven feed hence it leads to pucker. The image below shows Normal and correct pattern of a stitch. However feed pucker can be avoided by opting for advanced types of feed systems like compound.

Shrinkage Pucker: Shrinkage pucker occurs during the process of washing the thread in the seam, shrinks, pulling the fabric with it. Usually it takes place while using cotton threads. Shrinkage Pucker can be avoided by using threads with low shrinkage properties.

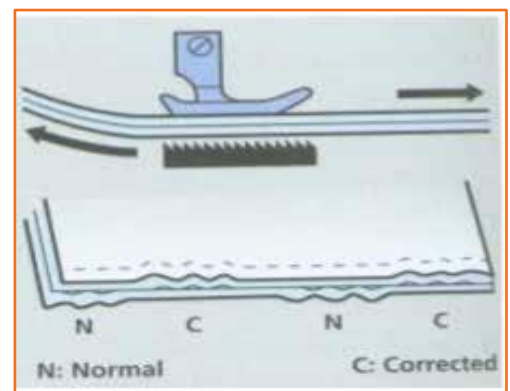

Fig.3.1.8: Feed Pucker



Fig.3.1.9: : Shrinkage pucker occurs during the

3.1.9 Sew and Apply Trims by Hand and Machine

Trims can be applied either by hands or by machines however it is important to check when to use hand trim for e.g. for fixing a button or to use a machine trim for e.g. modifying the stitch.

- Always choose the right method of repairing the production and make sure to re-make it as per the requirement and specification of the customer and of a company.
- Check if the machines are set up and are in good working conditions. To attain production targets machines should be working efficiently all the time.
- Sometimes, Hand sewing is required when there is a need repairing re-welting or piece welting. You need to know whether the repair is to be made by hand or machine, the main equipment used and their capabilities and what problems may occur when undertaking the repair and how to prevent/ rectify them. As adhesives will be used you need to know how to use and store them safely.



Fig.3.1.10: Seam Pucker

3.1.10 Maintain Workflow and Meet Production Target

Here are some of the tips with which work should be carried out so that the workflow can be maintained and production target can be achieved:

- Fabric's pieces and lining must be pinned or sewn together as per the requirement and they should be set in such a way that they are ready for assembly.
- One production's workflow should not affect the workflow of other production, handling of material should be very careful to keep away material from the risk of damage.
- All the production sections should work in synchronization with each other i.e. trimming should work in a way that spreading and cutting can work in sync with stitching and stitching can maintain coordination with embroidery, printing and so on. By doing so, a production target and quality products can be produced.
- Working in sync can improve efficiency in work.
- Always sort your work in such a way that it is in readiness for assembly.
- Each production should sort and place their work in such a way that it can be easily used at the next stage of production for e.g. if you are working at embroidery section then the fabric's embroidery should be placed in such a right order that it should not be a problem for a person in a stitching operation to arrange and stitch the fabric.

- One must be thoroughly aware about the tools, settings and equipment that are required to work on and how to handle materials without damaging them. They should know what a finished product looks like, so that they can have perfection in their working.
- Make sure to check the materials available in the stock, if it is not sufficient inform the concerned department to arrange one; it should not disrupt the workflow of other production.



Fig.3.1.11: Work flow at work place

3.1.11 Fabric Defects

Classification of defects

Certain defects are acceptable to some whereas unacceptable to others. fabric for curtain inner lining might not generally be judged with stringent dealings. Whereas that for top grade dress wear could also be rejected on the idea of a minuscule imperfection.

- Classification is that the categorization of defects into major and minor. Defects are classified relying on many factors. In some cases defects might not be defects within the first place. For instance: Barre in knitting appears within the sort of sequential horizontal lines on the fabric. this might simply be used as a sway and usefully incorporated in product. Laddering will be achieved as a sway by deliberately deactivating a needle within the bed.
- Generally the classification depends on the frequency of the defect. a little hole within the fabric might not cause problems however repeated little holes can clearly be problematic and so a significant defect.

The classification of defects depends on degree of visibility. for example registration problems will be neglected if there is only minor misalignment. Variation in matching of coloured shade is acceptable within bound limits.

1. **Major Defect:** A defect that, if conspicuous on the finished product, would cause the item to be second.
2. **Minor Defect:** A defect that would not cause the product to be termed as a second either because of severity or location.
3. **Second:** A 'Second' is a garment with a conspicuous defect that affects the saleability or serviceability of the item.

These faults have to be reported immediately to the supervisor. In case of not reporting, the defects will not be rectified and result is rework.

There are several defects related to fabrics. It is said that approximately 70% of the apparel industry's cost is spent on getting an excellent or a good quality standard fabric to meet client expectations and market reputation or competition. Commonly found defects are mismatch in threads, or using an incorrect stitching technique, improper creasing of any garment etc, similarly a garment can also be called faulty when it has color defect or size difference. Sizing defect must be handled carefully as it can deteriorate a garment where they can't be repaired and has to send for a re-making of the product which could be time and cost consuming for the industry. Hence it is very important to look for the material carefully. The material to be used should be free from the following faults:



Fig.3.1.12: Abrasion Mark

- **Abrasion Mark:** Abrasion mark is the mark which is formed where the fabric has been damaged on the outside due to friction that has occurred because of damaged operation through which it has been passed.

- **Misprinting:** misprinting is a common fault found in the making of a garment. It could be that, the garment is misprinted, or partially printed or over-lapped. For e.g. as highlighted in the Fig. on the left, the circles printed are not of the same size and shape hence it's a misprint.

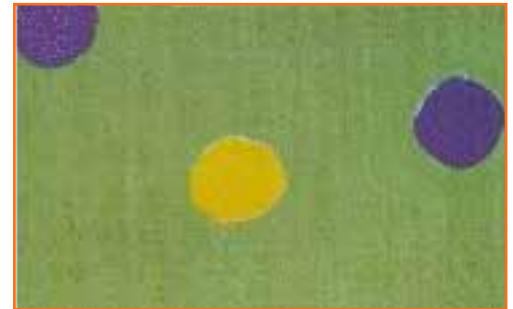

Fig.3.1.13: Misprinting

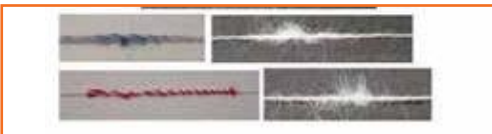

Fig.3.1.14: Double Pick

- **Double Pick:** Double pick can be explained as 2 yarns which are running concurrently, and regularly in the weft yarn. Refer to the image on the left to see the example of two yarns running parallel.

- **Oil Stains:** As shown in the Fig. on the left, oil marks are something that leaves stain on the fabric making it look ugly, and must be treated immediately as the fabric with oil stains can't be left unattended. It should be sent for the replacement.

Hole or a Bow can be caused due to faulty needles like bent or dull needle, hence make sure to check needles and if there are any bent or rusty, dull needles they should be the first thing to be replaced.



Fig.3.1.15: Oil Stains



Fig.3.1.16: Skew

- **Skew:** Deformation or twist in the construction of the fabric i.e. in yarn that comprise the fabric. The picture shows how skew is identified.
- **Dye Stain:** An area of discoloration which occurs because of unequal absorption of dye hence, always make sure to check that the material you are about use should not have any sort of discoloration. If so, then make sure to get it replaced.

Marker Making Defects

- Size Mixing. Components not correctly labelled in marker.
- Patterns facing incorrect direction on napped fabrics.
- Patterns facing in different direction (either way) on a one-way fabric.
- Garment Components omitted during marker making
- Patterns misaligned with respect to the fabric grain.
- Line definition poor (e.g., too thick chalk, indistinctly printed line) leading to inaccurate cutting.
- Mismatched checks and stripes.



Fig.3.1.17: Marker Making Defects



Fig.3.1.18: Plies misaligned

Common Spreading Defects

Plies misaligned:

- Incorrect tension of plies
- Fabric spread too tight or too loose, causing parts not to fit in sewing and finished garments not to meet size tolerances.
- Spread distorted by the attraction or repulsion of plies caused by excessive static electricity.
- Plies not all facing in correct direction (whether —one way|| as with nap, or —one way either way as with some check designs)
- UnacceptFig.damages situated in garment parts

Common Cutting Defects

- **Inaccurate cutting:** Distorted garment parts. Top and bottom plies of different size
- **Notches:** Misplaced, too deep, or omitted
- **Drill marks:** Misplaced not perpendicular through the spread
- **Frayed edges, fused edges:** Caused by a faulty knife not sharp enough, or rotating at too high a speed
- Marker incorrectly positioned on top of spread
- Slits opened inaccurately or omitted



Fig.3.1.19: Cutting Defects

- Mixed plies resulting in Shaded Garment parts when assembled
- Mixed Size parts resulting in uneven appearance
- Inconsistent Grain and Surface of the Skin

Bundling and Ticketing

Numbering or Pasting of a number sticker on all the components of all the garments. The number acts as the identification of the component and the lot from which the component is cut.

- **Bundling:** Assembling the cut components in small batches of pre-defined number as per the requirements of production system.
- **Ticketing:** The process of attaching a ticket to all the bundles that provides basic information about the bundle and the components in the bundle.

Important Points

- Numbering should be done on wrong side of fabric only.
- Number stickers should be checked for glue
- Numbering of a ply twice or skipping of a ply should not occur
- The information on bundle tickets must be accurate
- Care must be taken to avoid mixing of components of different sizes in a bundle
- Sewn on shade marking tickets falling off, damaging fabric, omitted, misplaced or wrongly numbered
- Adhesive shade marking tickets falling off or sticking too hard , omitted, misplaced, wrongly numbered
- Bundles or boxes not stacked in box, or rolled in correct order in bundles or rolled or folded too tightly causing creases
- Work tickets, coupon payment tickets or progress tickets omitted , misplaced or mixed makes both quality and quality control difficult
- Wrong Size , Wrong Shade, wrong type of trimmings put in Bundle



Fig.3.1.20(a): Unmatched Trimmings



Fig.3.1.20(b): Matched Trimmings

Common Problems of Fusing

- Discoloration after fusing - The temporary or permanent change in shade, color of a fabric caused by the action of heat on certain dyes during fusing.



Fig.3.1.21(a): Normal Fabric

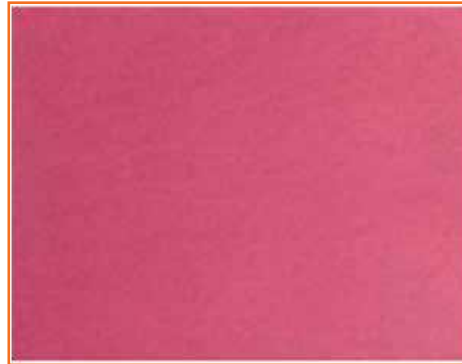

Fig.3.1.21(b): Discoloration after fusing

Strike through

- Strike through means that the adhesive resin appears on the outer face of the fabric being fused



Fig.3.1.22(a): Ideal fusing in fabric



Fig.3.1.22(b): Strike through in a fabric



Fig.3.1.22(c): Interlining shrinking

Strike Back



Fig.3.1.23(a): Ideal fusing



Fig.3.1.23(b): Strike Back

Shine / Glazing and Discoloration

- The temporary or permanent change in shade, colour of a fabric caused by the action of heat on certain dyes during fusing.

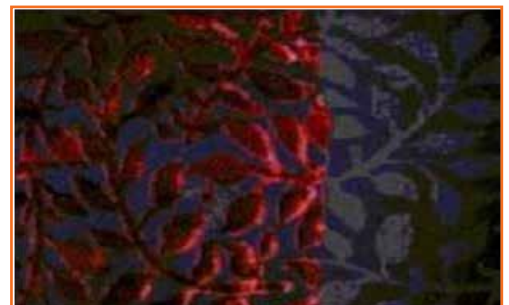

Fig.3.1.24: Glazing and Discoloration



Fig.3.1.25: Fusing distortion

Fusing distortion

- Fusing distortion means garment panels are distorted during the fusing process. This problem should be prevented as distorted garment panel after fusing cannot be corrected other than discarded as waste.

Fusing delamination

- Fusing delamination, sometimes appear as bubbling or rippling is the complete breakdown of bond between fusible interlining and fabric surface. It is normally found after the garment has been dry cleaned or washed.

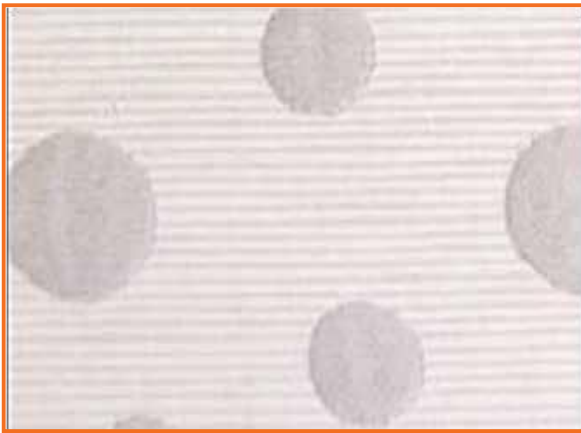

Fig.3.1.26(a): Ideal fusing

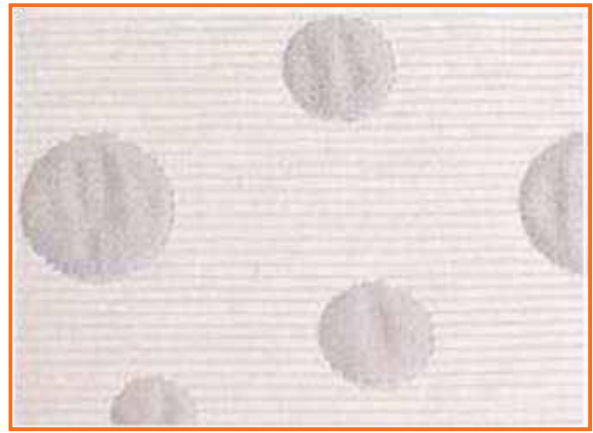



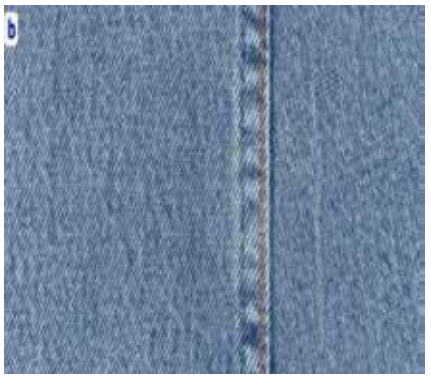
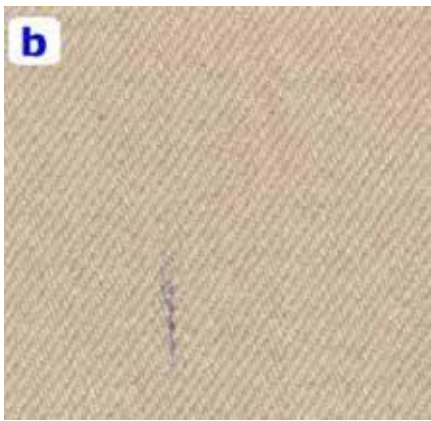

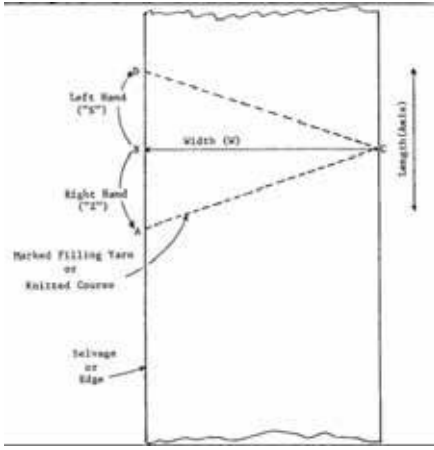

Fig.3.1.26(b): Fusing delamination

Common Woven Fabric Defects

Defect	Explanation	Severity	Photograph
Defects of Woven Fabric			
Dropped Pick	Caused by the filling insertion mechanism on a shuttle less loom not holding the filling yarn, causing the filling yarn to be woven without tension. The filling yarn appears as "kinky."	Major	
End Out	Caused by broken yarn and loom continuing to run with left end.	Major	
Slub	Usually caused by an additional piece of yarn that's woven into fabric. It can even be caused by thick places in the yarn. Often is caused by fly waste being spun in yarn in the spinning process.	Major or Minor	
Knots	Caused by tying spools of yarn together	Usually Minor	

<p>Mixed End (Yarn)</p>	<p>Yarn of a different fiber blend used on the wrap frame, resulting in a streak in the fabric.</p>	<p>Usually Major</p>	
<p>Mixed Filling</p>	<p>Caused by bobbin of lightweight yarn or different fiber blend used in filling. Will appear as a distinct shade change</p>	<p>Major</p>	
<p>Soiled Filling or End</p>	<p>Dirty, oil looking spots on the wrap or filling yarns, or on package-dyed yarn</p>	<p>Major</p>	
<p>Askewed or Bias</p>	<p>Condition wherever filling yarns are not square with wrap yarns on woven fabrics or wherever courses don't seem to be square with wale lines on knits.</p>	<p>Major or Minor</p>	



Pin holes	Holes along selvage caused by pins holding fabric while processes through stenter frame	Major if extends into body of fabric	
Straying End	Caused when an end of yarn breaks and loose end strays and is knit irregularly into another area.	Major	
Bowing	Usually caused by finishing in knits ,the course lines lie in an arc across width of goods.	Major on stripes or patterns Minor on Solid color	

Fig.3.1.27: Common Woven Fabric Defects

Accessories Defect

Zippers		
Slider defect	<p>Won't Lock: Not apparent without testing by placing Zipper slider in locked position and applying tension.</p> <p>Faulty Dimension: Not readily apparent. May cause either a hard or a loose operating zipper. Either condition may result in zipper failure before garment is worn out.</p> <p>Crushed Slider: May be due to improper garment pressing or due to padding or compensating springs in the presses not being in best condition.</p>	

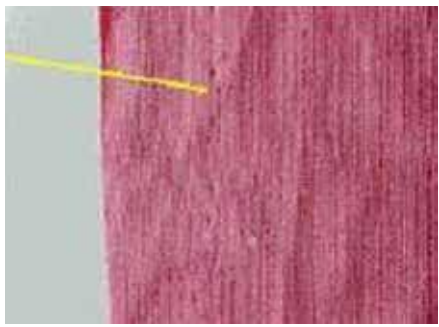
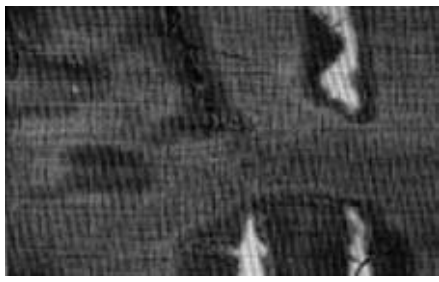
Tarnished: Does not generally interfere with operating qualities but is a matter of appearance only. Judging" this as a defect depending upon degree of tarnish. Burn or Rough Spots Not immediately apparent. Can cause snagging and early wear on the upper tape. Lock Prong Interferes Indicated by pull-tab not staying in locked position or slider not moving freely after being released from locked position.

Weak Slider Bodies: Can best be determined with correct testing equipment. However, manifests itself by slider becoming compressed or crushed below minimum pressure or becoming distorted enough to form hard operation.



Chain or Teeth Defect

Improper Dimensions: Not always apparent unless slider works with great difficulty or operates too easily. Zipper' may give initial satisfactory operation but fail after only moderate use and especially after laundering or dry cleaning.

Miss meshed and Unmeshed Teeth: Readily visible, particularly in large. Usually results in inoperable zipper. Missing Teeth: Readily visible, will result in early failure of the zipper.

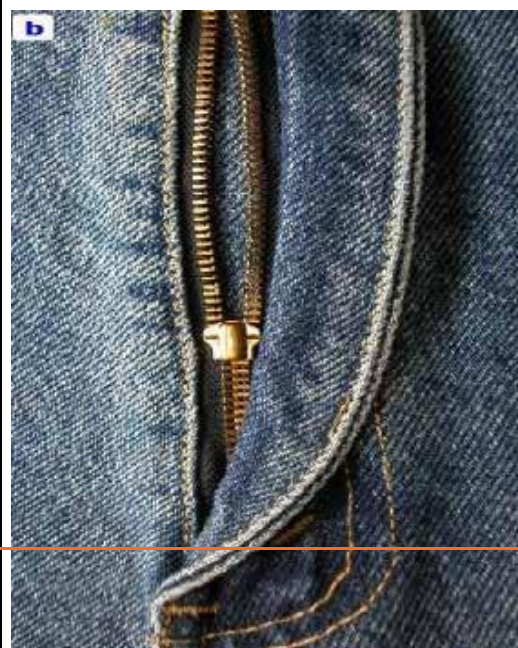

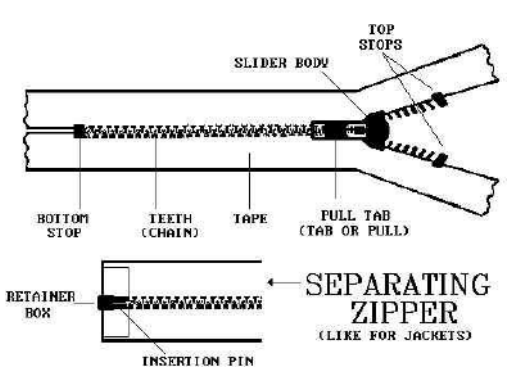
	<p>Misplaced Teeth: This refers to a tooth being out of position, and occasionally may involve two or three teeth. Seriousness ranges from trifling to almost as serious as a missing tooth depending upon the degree of misplacement and general design of zipper.</p> <p>Off color: This defect is quite apparent. Zipper makers usually carry an entire range of tape colours. because of similarity of different colours, one may be mistaken for another. it's also possible, because of color similarities or distinction in dye lots that the {two the 2} halves of the zipper can have two different shades of tape.</p> <p>Humpy Chain: readily noticeable by its waviness. Causes issue at sewing operation and distorts finished garment's look.</p> <p>Cord not attached to Tape: because of skipped stitches during operation of sewing cord to tape. Not readily apparent however under strain, cord and teeth can rip away from tape and render zipper and garment unusable. Length: Improper zipper length for given opening.</p>	
--	---	--

<p>Top or Bottom Stop Defects</p>	<p>Missing Top or Bottom Stop: Readily apparent and will end in zipper failure. If facilities for attaching a top or bottom stop don't seem to be available, then the complete zipper ought to get replaced. In some instances, bottom stops are hooked up at garment plant. an improperly or poorly attached bottom stop is also result of carelessness on a part of the operator or of improper functioning of the bottom stop machine.</p>	
-----------------------------------	--	--

Snap Fasteners

<p>Hard Action</p>	<p>In light-weight goods this may result in stud or socket pulling through the material. The snap fastener manufacturer can be of help in recommending proper tension of stud in socket for weight of garment material.</p>	
--------------------	---	--







Light Action	Snap fastener does not stay closed because of lack of proper tensions. Same comment applies as for tight closure.	
Hooks & Eyes	<p>Improperly Applied: This is usually caused by a careless operator or improperly adjusted attaching equipment, and corrections are usually simple when apparent.</p> <p>Improper Alignment: Gauges are available for attaching equipment to assure proper alignment in positioning. this can be a necessary if garment is to own a properly tailored look. If the top of the zipper is extended into the waistband of the garment, than the hook and eye ought to be offset to prevent it from hit the zipper material.</p> <p>Poor Finish: May be the result of improper finishing or pocking of the metal surface and, while this defect dose not interferes with the functional operation, it may not leave the desired finished appearance of the garment.</p> <p>Tight/Loose Closure: Attaching equipment bad fitt with an adjustable feature permitting secure application of hook and eye to either light-weight or heavyweight goods. If closures seem too tight, then one should instantly check the attaching equipment for correct adjustment.</p>	
Buttons		
Rough or Dull Surfaces	This fault is not so serious except in cases of extreme roughness or poor surface appearance.	
Non-Uniform. Inaccurately Spaced Chipped or Blocked Sew Hole:	This type of defects cannot be noted during the garment manufacturing operation and can slip inspection unnoticed but it frequently causes needle breakage or cut thread.	

Fig.3.1.28: Accessories Defects



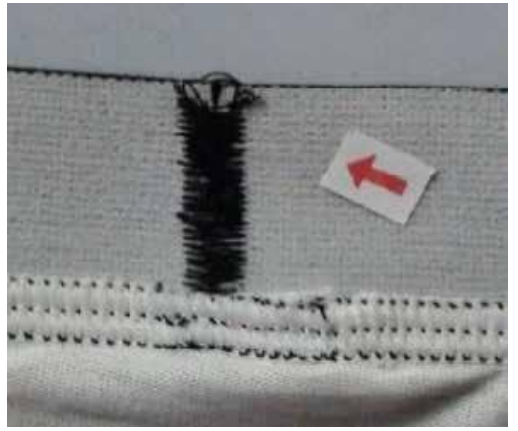

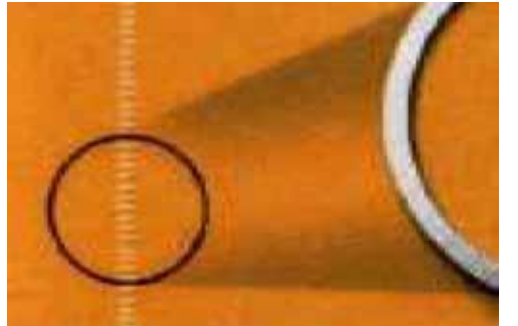
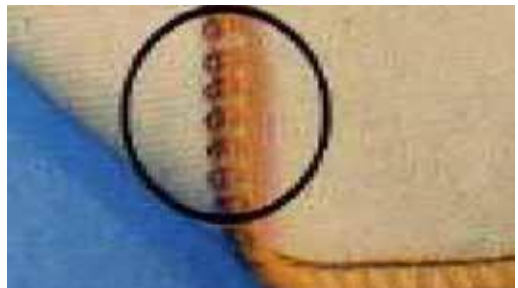
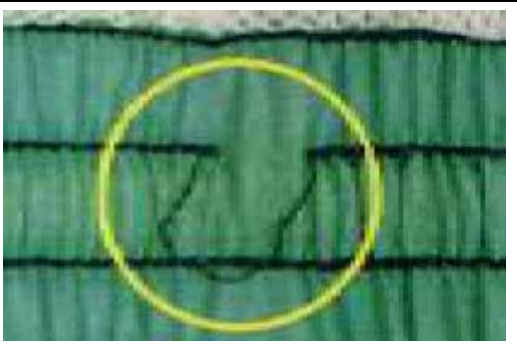
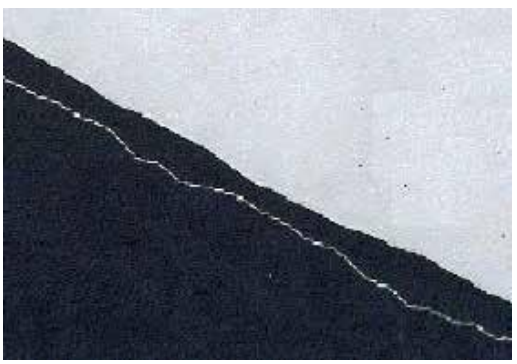
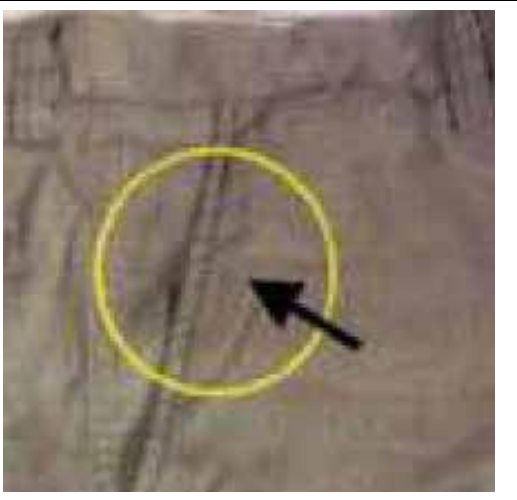
Stitch and Seam Defects

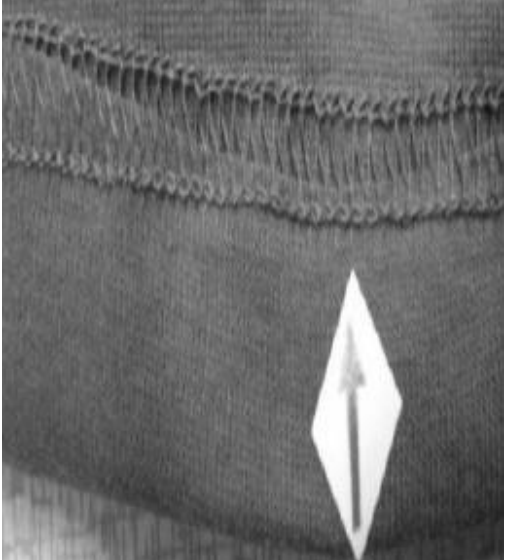
Type of Defects	Description	Photograph
Broken stitches	Caused due to: <ul style="list-style-type: none"> • Too thick/ too thin a thread for the needle • Needle heat • Operator working non-rhythmically • Too tight tension 	
Skipped stitches	Caused due to: <ul style="list-style-type: none"> • Hook irregularly failing to pick up the loop of thread from a needle's eye 	
Seam Grinning	Caused due to: <ul style="list-style-type: none"> • The Seam itself may open and produce a Gap between two pieces of fabric • Arising from too loose a tension or too large stitch length or use of a wrong stitch type. 	
Unbalanced stitch	Caused due to: <ul style="list-style-type: none"> • Arising from unbalanced tension of needle thread and bobbin/looper thread. 	

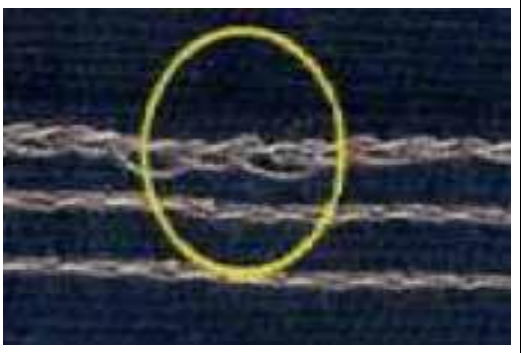
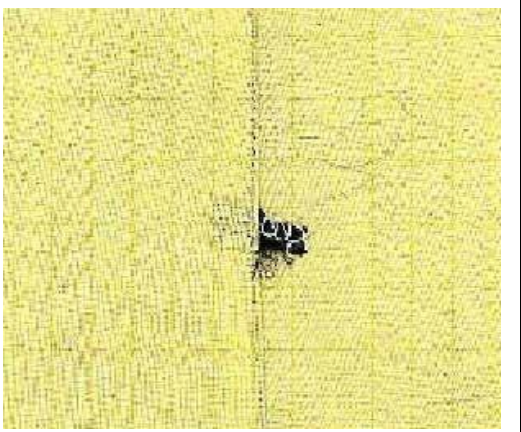
<p>Improperly formed Stitches</p>	<p>Caused due to:</p> <ul style="list-style-type: none"> • Bad thread tension • Ill fitting machine components 	
<p>Irregular or incorrect shape of sewing line</p>	<p>Caused due to:</p> <ul style="list-style-type: none"> • Badly set guide, • Handling error 	
<p>Twisted seams</p>	<p>Caused due to:</p> <ul style="list-style-type: none"> • Improper alignment of fabric parts, • Mismatched notches, components off grain 	
<p>Mismatched stripes or checks</p>	<p>Caused due to:</p> <ul style="list-style-type: none"> • Mishandling by operator • Incorrect cutting 	

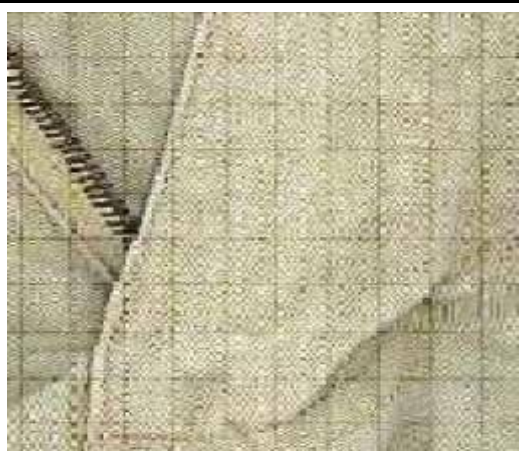
Insecure stitching back	<p>Caused due to:</p> <ul style="list-style-type: none"> • Rows do not cover the first row of stitching-Manual error 	
Uneven width of inlay	<p>Caused due to:</p> <ul style="list-style-type: none"> • Bad handling by operator • Incorrectly set guide, incorrectly set folder 	
Linings too full, too tight.	<p>Caused due to:</p> <ul style="list-style-type: none"> • Operator twisted or stretched extensively during Sewing 	
Uneven Stitch Density	<p>Caused due to:</p> <ul style="list-style-type: none"> • Operator causing the machine to snatch and does not allow the machine to control fabric feeding. 	

Wrong Stitch density	<p>Caused due to:</p> <ul style="list-style-type: none"> • Too high SPI give rise to jamming and rupture of fabric • Too low SPI give rise to weak seams and seam grinning 	
Mismatched seams	<p>Caused due to:</p> <ul style="list-style-type: none"> • Edges of the upper and lower fabric parts not matched during sewing, causing the seams to shift 	
Loose Stitch	<p>Caused due to:</p> <ul style="list-style-type: none"> • Unbalanced seam sewing thread tension not set properly 	
Extraneous part caught in the seam	<p>Caused due to:</p> <ul style="list-style-type: none"> • Handling error 	

<p>Garment parts Cockling, Pleated, Twisted, Showing Bubbles</p>	<p>Caused due to:</p> <ul style="list-style-type: none"> • Handling error • Usage of wrong interlining/fusing under improper conditions 	
<p>Components of features wrongly positioned or misaligned</p>	<p>Caused due to:</p> <ul style="list-style-type: none"> • Incorrect marking • Incorrect sewing not following the marker 	
<p>Seam Slippage</p>	<p>Caused due to:</p> <ul style="list-style-type: none"> • Insufficient thread tension • Low count, unbalanced weave and filament yarns. 	
<p>Thread Breakage</p>	<p>Caused due to:</p> <ul style="list-style-type: none"> • Improper m/c settings • Incorrect threading • Excessive needle heat • Incompatible needle, thread and fabric, damaged machine parts 	





Yarn Severance	<p>Caused due to:</p> <ul style="list-style-type: none"> • Incorrect needle point • Damaged needle • High machine speed 	
Puckering	<p>Caused due to:</p> <ul style="list-style-type: none"> • Tension pucker • Feed pucker • Puckering due to differential shrinkage • Puckering due to structural jamming 	
Ragged Edges	<p>Caused due to:</p> <ul style="list-style-type: none"> • Knives on automatic sewing machine not dipping smoothly. 	
Uncut thread	<p>Caused due to:</p> <ul style="list-style-type: none"> • Operators' negligence • Malfunctioning thread trimmer in automatic machines 	
Oil stains	<p>Caused due to:</p> <ul style="list-style-type: none"> • Malfunctioning machines 	

Fig.3.1.29: Seam defects

Processes to Rectify Few Defects

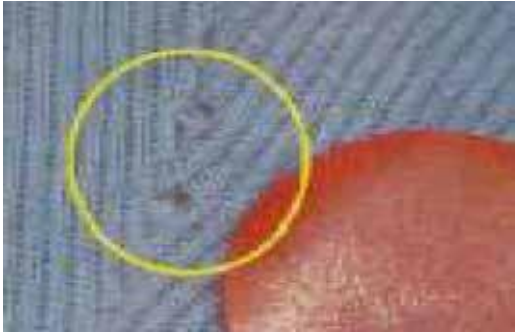
Defects	Rectification
Restitched Seams / Broken Stitches	<ul style="list-style-type: none"> Using better quality sewing threads Ensure proper machine maintenance
Open Seam- Seam Failure- Stitch	<ul style="list-style-type: none"> Better quality threads Proper size thread for application Proper tension
Seam Slippage	<ul style="list-style-type: none"> Change seam type if possible Increase seam width Optimize the stitches per inch.
Excessive seam Puckering	<ul style="list-style-type: none"> Correct thread type and size. Sew with minimum sewing tension to get a balanced stitch Machine needle, bobbin and threads are set properly according to the fabric to be sewn.
Knits & Stretch woven puckering	<ul style="list-style-type: none"> Set the machine properly according to the fabric Minimum pressure foot pressure
Improper Stitch balance	<ul style="list-style-type: none"> Use quality thread Properly balance the stitch so that the needle and bobbin threads meet the middle of the seam. Always start by checking bobbin tension to make sure it is set correctly, so that minimum thread tension is required to get a balanced stitch.
Raggedged/Inconsistent Edge	<ul style="list-style-type: none"> Make sure the sewing machine knife are sharpened and changed often. The knife should be adjusted in correct form in relationship to the "stitch tongue" on the needle plate to get the proper seam width.
Improper Stitch balance – 504 Overedge Stitch	<ul style="list-style-type: none"> Use Quality thread Balance the stitch properly so that if the looper thread is unraveled, the needle loop lays over half way to the next needle loop on the under side of the seam
Raggedged/Inconsistent Edge	<ul style="list-style-type: none"> Make sure the sewing machine knife are sharpened and changed often The knife should be adjusted properly in relationship to the "stitch tongue" on the needle plate to obtain the proper seam width.

Fig.3.1.30: Rectification of defects

Resources

Scan the QR codes or click on the link to watch the related videos.

Descriptions	QR Codes
Categorization of garment defects	 https://youtu.be/SPtD6mAZ0GU

Industry Visit

The purpose of visiting an apparel manufacturing unit is to get hands on knowledge about various processes involved in the work of an SMO. During the visit you have to interact with Sewing Machine Operators and supervisors to understand how work is done in industry. Make sure that you keep a notebook handy and note down any important points that come up during your interaction at the apparel manufacturing unit. When you go to an apparel manufacturing unit, you should:

- Know about the production system.
- Inspect stitched products against specifications.
- Analyze how SMOs:
 - » Inspect stitched products against specifications
 - » Carryout alterations
 - » Sew and apply trims by hand and machine
- Also Understand the inspection and possible defects.
- Ask questions to SMOs/supervisors if you have any query.

Exercise

1. Quality Plays important role in bulk garment production.
 - a) TRUE
 - b) FALSE
2. Skip stitch is a defect created by:
 - a) Mis handling material by operator
 - b) Fault in Machine
 - c) Wrong type of stitch used on fabric
 - d) All of above

3. Puckering defect occurs due to:
 - a) Tight Bobin Thread
 - b) Tight Needle Thread
 - c) Incorrect pressure foot
 - d) All of above
4. 100% Inspection is the cheapest option for garment inspection:
 - a) TRUE
 - b) FALSE
5. Correct seam allowance is important to sew quality product:
 - a) TRUE
 - b) FALSE





4. Maintain Work-Area, Tools and Machines

Unit 4.1 - Maintain Work Area, Tools and Machines



Key Learning Outcomes

At the end of this module, participants will be able to:

1. Practice the machine safety and maintain machines properly.
2. Carry out basic maintenance of machine.
3. Maintain tools and equipments and handle them safely.
4. Make hazard free working area.
5. Use materials to minimize waste.
6. Carryout running maintenance within agreed schedules.
7. Carry out maintenance and/or cleaning within one's responsibility.
8. Work in a comfortable position with the correct posture.
9. Use cleaning equipment and methods appropriate for the work to be carried out.
10. Dispose of waste safely in the designated location.
11. Store cleaning equipment safely after use.
12. Carryout cleaning according to schedules and limits of responsibility.

UNIT 4.1: Maintain Work Area, Tools and Machines

Unit Objectives

At the end of this unit, participants will be able to:

1. Practice the machine safety and maintain machines properly.
2. Carry out basic maintenance of machine.
3. Maintain tools and equipments and handle them safely.
4. Make hazard free working area.
5. Use materials to minimize waste.
6. Carryout running maintenance within agreed schedules.
7. Carry out maintenance and/or cleaning within one's responsibility.
8. Work in a comfortable position with the correct posture.
9. Use cleaning equipment and methods appropriate for the work to be carried out.
10. Dispose of waste safely in the designated location.
11. Store cleaning equipment safely after use.
12. Carryout cleaning according to schedules and limits of responsibility.



Fig.4.1.1: A well maintained machine shop

4.1.1 Introduction

Machines are essential to modern production. However, along with accrued productivity, they have brought hazards into the workplace. Proper management of machine hazards has traditionally been seen as expensive and a constraint on productivity. In general, the garment manufacturing trade is considered to be less dangerous than alternative industrial sectors and, therefore, safety policy is a low priority in several enterprises. For example, it has been ascertained that some workers remove guards protective belts from sewing machines, and manual cutting machines are operated with naked hands.

Machine breakdown is a common reason behind production delay affecting delivery schedules. Considering the importance of meeting delivery dates, a competitive enterprise cannot afford penalties for delay due to machine breakdown. Therefore, proper maintenance of machines to prolong their economic life, reduce breakdowns, prevent defective outputs and guarantee safe operation ought to be of additional importance. Protective staff against pollution from the frequent use of solvents for cleaning and the existence of cotton or other fibers within the surroundings ought to also be taken into consideration. Maintenance and safety measures to eliminate these hazards and increase machine productivity, beside affordable techniques for environmental control, are mentioned below.

4.1.2 Maintain Machines Properly

A poorly maintained machine is inefficient, if not dangerous. It will also have frequent breakdowns and quality issues. Proper maintenance isn't lost production time; it's an investment for higher productivity and lower repair prices. Nonetheless, in several corporations, machines are maintained only if they break down. This can be as a result of a number of reasons:

- Machines are owned by the contractors or they're leased.
- No maintenance personnel are available.
- No time to maintain machines is allotted under production time.
- There is a powerful belief that maintenance means cost.
- Some machines are not simple to maintain.

Machine down-time affects production and causes delays. Defects are also made inflicting quality and productivity issues. Machine maintenance ought to, therefore, be planned and coordinated with supervisors and employees. Employees ought to be involved in machine maintenance and should be equipped a basic tool kit to include tweezers, small screwdriver, machine brush, oil can and material wipes. One of the basic training skills is to train employees to do routine machine maintenance such as:

- Removing lints
- Cleaning the tension assembly
- Cleaning the feed dog assembly
- Cleaning the bobbin area
- Lubricating the machine

4.1.2.1 Removing Lint

Lint: With proper care, a sewing machine can last for many, many years. Fabric and thread are a combination that is going to produce lint. Lint can build up in unseen areas of machine leading to wear and tear. To keep the sewing machine running smoothly, good quality thread should be used and simple maintenance should be performed regularly. One of the most important things is to clean out the pieces of lint leftover from bits of thread and fuzzy fabric. Sewing with thick, furry fabrics (such as polar fleece), will need cleaning of the sewing machine frequently. One should open all areas that can be cleaned and clean the lint out of the machine. Usage of brush should be done to remove lint in cracks and crevices and from under the bobbin case.

Requirements: Sewing machine

- Lint brush
- Small soft brush
- Clean lint free cloth
- Compressed air (optional but helpful)
- Light source
- Screw drivers

4.1.2.2 Cleaning the Bobbin Area

- **Step 1:** Turn off and unplug the sewing machine.
- **Step 2:** Remove the bobbin cover and the bobbin.
- **Step 3:** Using a small lint brush (many machines come with one), carefully remove any lint from the bobbin area. Be especially sure to remove any lint from crevices and tight places, since compacted lint can actually stop the machine from running.
- **Step 4:** Using the lint brush or canned air, remove the lint from the area around the needle, the presser foot and the thread guides.
- **Step 5:** Remove any lint from the inside of the doors and lids of the sewing machine.
- **Step 6:** Replace the bobbin and the bobbin cover.
- **Step 7:** Plug the sewing machine back in and turn it on.

Note: Make sure to check that after cleaning all the machine parts are properly placed and tightened. It should be safe for using it the next time.



Fig.4.1.2: Cleaning the bobbin and case

4.1.2.3 Cleaning the Tension Assembly

Maintaining the machine is important to keep it in good condition and to avoid unnecessary service costs. Keeping the tension assembly clean is one of the maintenance procedures that, if performed on a regular basis, can help ensure that your stitching is accurate and precise. The following steps assist the cleaning of the sewing machine tension assembly.

- **Step 1:** Clean your machine often. Each stitch is precise and even a bit of lint collected on the tension assembly can cause problems. Make it a habit to clean your sewing machine after any large project.
- **Step 2:** Raise the pressure foot to release the tension on the disks. Gently run the folded edge of a clean piece of lint free cloth through the tension disks. Compressed air will also dislodge any bits of thread or lint.
- **Step 3:** Remove all lint along the thread guides using a small brush or clean cloth.
- **Step 4:** Check the bobbin area of the machine. The bobbin controls the lower tension and can be a source of built up lint. Depending on the type of machine you have, the bobbin consists of the bobbin, case and on some models a removable hook race. Remove these according to your instruction manual and clean with a cloth or small brush.
- **Step 5:** Do a final check to make sure the tension is correct and that the bobbin assembly is in place properly before you begin your next project.

4.1.2.4 Cleaning the Feed Dog Assembly

The feed dogs on a sewing machine help move the fabric underneath the needle. If they're not operating properly, damage to the machine or fabric can occur. Feed dog assembly maintenance is essential to smart sewing. Use the steps below to guide you through the procedure.

- **Step 1:** unplug the machine and examine the feed dogs. The newer machines have metal feed dogs, however older models could have rubber ones, which regularly need replacement. Examine the feed dogs and check for damage.
- **Step 2:** remove the throat plate, which is the covering over the feed dogs, and clean it with a soft fabric. Use a small soft brush to wash the feed dogs. ensure to get rid of all lint and thread from the grooves of the teeth. Some machines have an adjustment that lowers the feed dogs for specific sewing procedures. they must be in the raised position for better viewing during the cleanup method.
- **Step 3:** Clean the area around the feed dogs with a soft brush. compressed gas could be a sensible choice to use in the small tight areas.
- **Step 4:** Wipe down all areas with a clean, lint free fabric before replacing the throat plate.
- **Step 5:** Prepare to clean the feed dogs and all other areas that lint could accumulate on, after each project. Your sewing machine will last longer and need fewer repairs if kept clean and lint free.

4.1.3 Steps in lubricating machine

In order to make sure that your sewing machine enjoys the long life it was engineered for, it is important to repair it regularly using proper maintenance techniques. One of the best things you can do to keep your sewing machine running smoothly is to lubricate it using sewing machine oil. Sewing machine oil isn't something you borrow from the garage. It is clear white oil. Make sure to use the right oil. Refer to your owner's manual for the right spots to oil. Some of the older machines have these areas marked.

After oiling your machine run stitches on some scrap cloth before you tackle your project. This enables oil to escape on to the scraps, if it's going to, rather than the project you're working on. Oiling the machine not only lubricates your moving elements, to prevent wear, it reduces the chance of rust. Rust forms rapidly with any moistness, even just the humidness in the air. Surface rust will act just like loose sand grain in your machine, and make excess wear.

- **Step 1:** Purchase a high-quality brand of sewing machine oil from a sewing store or other specialty merchandiser. Higher quality typically comes with a higher price tag, however the value of good sewing machine oil is favorable to the prices involved repairing or replacement an entire sewing machine.
- **Step 2:** unplug your sewing machine. check that its power switch is set to 'off.' as a result of you will be dealing with fluid, it is especially important to make absolutely certain any power supply is disconnected.
- **Step 3:** Drop a single drip of sewing machine oil onto the mechanism that drives the sewing needle. If you bought quality sewing machine oil, more than one drop can usually not be necessary.
- **Step 4:** Repeat Step three, applying one drop of oil to each part of your sewing machine that moves. Consult your sewing machine owner's manual if you would like instruction on the way to access any moving parts which will be contained beneath the casing of the machine.
- **Step 5:** allow the oil to absorb by letting your sewing machine stand for a few minutes. Most experts counsel that fifteen to half-hour could be a sensible window of time to let your machine stand while the stitching machine oil works its magic.
- **Step 6:** Plug your sewing machine back in. once you have safely done so, turn the power switch to 'on.'
- **Step 7:** Feed some scrap fabric through the sewing machine, running its moving elements at a slow but constant rate. this may allow the oil to spread equally throughout the parts that need lubrication to maintain best performance.

Tips & Warnings

- Never lubricate any electrical part of your sewing machine. This may damage to your sewing machine, and could result in an electric shock.

4.1.4 Machine Guards

There are different safety guards given in the sewing machine that are vital to use and it's also essential to check that the right safety guard is in place as per the need. Below are given the machine guards of a sewing machine.

- **Finger guard:** while guiding the fabric under the presser foot the fingers may accidentally cross into the path of the needle. Hence, finger guard is attached to the presser foot to avoid such accidents. This is very important safety feature.



Fig.4.1.3: Finger Guard

- **Eye guard:** Eye guard is important in cases where the operator is working on the fabric which has many fibers, hence eye guard protect eyes from getting tired. It also helps in protecting them against any little cloth fabric like that of wool or dust fibers. Eye guard is also used as a protection against needle-breakage in high speed sewing machines.



Fig.4.1.4: Eye Guard

- **Belt guard:** Belt guard is a cover attached to the belt pulley assembly and the ad wheel. In industrial sewing machines the pulley and the belt move at very high speeds. Hence there is always a risk of hand or hair getting caught in the belt pulley therefore it is important to have a belt guard as it protects the operator from such accidents.
- **Motor pulley guard:** Motor pulley guard is attached to the motor under the Fig, like the belt guard, motor pulley guard protects our body Parts from getting caught in the wheel and belt attached to the motor below the Fig.

4.1.5 Troubleshoot Common Machine

In several cases machine issues are due to the employee not having received correct training in basic machine maintenance. This causes issues that need to be corrected by a certified mechanic/technician. All garment enterprises suffer from such issues to varying degrees. Some common causes are:

- Incorrect needles
- Incorrect machine settings for the fabric
- Inexperienced staff
- Inexperienced mechanics/technicians
- Fabric finishes.

On-the-job training sessions could also be organized for beginners as part of their training period. Enlist the assistance of senior operators with teaching skills. group work will provide good opportunities for these training sessions. Sessions ought to embrace acquiring the essential sewing skills and troubleshooting sewing issues.

4.1.6 Carry out Basic Maintenance of Machine

It is important to carry out basic maintenance of own machine and surroundings. While operating a sewing machine we can keep a check of these two maintenances by keeping an eye on the needle point i.e.

- Must check the needle point and stitch quality while working. Be attentive and look for any kind of oil leakage is found, replace (or inform) immediately. For hazard free environment always keep the hook area clean and tidy.
- **Routine Maintenance:** This covers sub kinds of maintenance i.e.
 - » **Daily maintenance of the machinery:** While carrying out the daily maintenance one must look for whether the machine and its area is clean, look for threading of the machine, quality and quantity of the oil.

Make sure to switch off the machines after operation this is one of the most important part of daily maintenance. Keep a check on needle tip and needle bend it should not be dull or rusty at all.
 - » **Weekly maintenance:** Consists of checking up the oil level and oil color in the machine. Make sure to remove the presser foot, throat plate and the feed dog too and clean them all thoroughly. Hook timing and clearance is also adjusted weekly so that the machine can work efficiently.
 - » **Monthly maintenance:** While keeping an eye on monthly maintenance of the machinery it is very important check oil flow in the pipeline, refill the oil up to its maximum level for efficient and flawless performance.

4.1.7 Sewing Machine Safety Tips

Sewing machines do involve electricity, moving parts and sharp needles, therefore safety is a concern. Some sewing machine safety tips are as follows:

- Keep your fingers off from the needle. experienced sewists may even be more apt to do this than beginners. about 60 minutes of the sewing machine related injuries treated in a hospital each year are puncture wounds from needles.
- Minimize distractions, and do not operate your sewing machine once you are tired or under the influence of alcohol. sewing could be a lot easier once you're feeling refreshed and relaxed, and it's also safer.
- Turn off and unplug your sewing machine once you are away from it for more than a few minutes. sewing machines will generate considerable heat once left on, and a lightning strike once a sewing machine is plugged in can cause irreversible harm. consider obtaining a surge protector to plug your machine into, just in case.
- Be aware of cords. attempt to keep cords towards the back of the machine and not draped across the floor wherever you (or somebody else!) is probably going to trip over them. If they do need to run across the ground, consider tape them down-- or simply notice somewhere else to work.
- Have your machine serviceable often. Not only will this keep your machine in top operating order, potentially dangerous repairs are more likely to be detected before they cause a problem.
- Always disconnect the machine and use caution once replacing parts like lightbulbs.
- Don't sew over straight pins. At the very least this can bend the straight pins and compromise your sew quality, however the straight pins also are susceptible to breaking, and very likely might end up in your finger (or worse).



Fig.4.1.5: Advanced Sewing Machine

- Don't force your machine to stitch through thick or tough material. you may damage your machine or cause injury to yourself. Your project may need an industrial strength sewing machine.
- Consider the ergonomics of your sewing Fig.and chair. If your sewing machine is too high it'll cause strain on your back. Your feet ought to be flat on the floor and your elbows bent at a 90 degree angle whereas you are stitching.
- Wear shoes while operating your machine. This one may appear a bit silly, however your foot pedal might break, and if you're wearing shoes, your feet will be protected. Stepping on stray needles, or dropping needles, scissors or a rotary cutter on your foot while stitching is additionally a prospect while stitching.
- Use care when eliminating used sewing machine needles. Prescription bottles or a mint tin are excellent for this. just take care you mark it clearly therefore you do not mistake it for your sensible needles.
- Your sewing area ought to be well lit. this can reduce strain on your eyes and assist you avoid leaning in unnecessarily near your machine.

Resources



Scan the QR codes or click on the link to watch the related videos.

Descriptions	QR Codes
Maintenance of single needle sewing machine	 https://youtu.be/6iE2DT6LVpg

Industry Visit

The purpose of visiting an apparel manufacturing unit is to get hands on knowledge about various processes involved in the work of an SMO. During the visit you have to interact with Sewing Machine Operators and supervisors to understand how work is done in industry. Make sure that you keep a notebook handy and note down any important points that come up during your interaction at the apparel manufacturing unit. When you go to an apparel manufacturing unit, you should:

- Know about the production system.
- Understand the machine safety and maintenance rules of industry.
- Analyze how SMOs:
 - » Maintain machines properly.
 - » Carry out basic maintenance of machine.
 - » Maintain tools and equipments and handle them safely and use materials to minimize waste.
 - » Work in a comfortable position with the correct posture.
 - » Dispose of waste safely in the designated location.
 - » Store cleaning equipment safely after use.
- Ask questions to SMOs/supervisors if you have any query.

5. Maintain health, Safety and Security in the Finishing Department with Gender & PwD Sensitization



Unit 5.1 – Maintain Health, Safety and Security at Work Place

Unit 5.2 – First Aid & CPR

Unit 5.3 – Sensitivity towards People with disability and Gender Equality



Key Learning Outcomes

At the end of this unit, participants will be able to:

1. Comply with health and safety related instructions applicable to the workplace.
2. Use and maintain personal protective equipment as per protocol.
3. Maintain a healthy lifestyle and guard against dependency on intoxicants.
4. Follow environment management system related procedures.
5. Identify and correct (if possible) malfunctions in machinery and equipment.
6. Report any service malfunctions that can not be rectified.
7. Store materials and equipment in line with manufacturer's and organizational requirements.
8. Safely handle and move waste and debris.
9. Minimize health and safety risks to self and others due to own actions.
10. Seek clarifications, from supervisors or other authorized personnel in case of perceived risks.
11. Monitor the workplace and work processes for potential risks and threats.
12. Carryout periodic walk-through to keep work area free from hazards and obstructions, if assigned.
13. Report hazards and potential risks/threats to supervisors or other authorized personnel.
14. Participate in mock drills/ evacuation procedures organized at the workplace.
15. Undertake first aid, fire-fighting and emergency response training, if asked to do so.
16. Take action based on instructions in the event of fire.
17. Follow organization procedures.
18. Analyze the First Aid & CPR

UNIT 5.1: Maintain Health, Safety, and Security at Work Place

Unit Objectives

At the end of this unit, participants will be able to:

1. Identify methods to be vigilant for potential risks and threats associated with the workplace.
2. Handle tools and equipment in work area.
3. Check the workplace and work processes for risks like fire, electric shocks, etc.
4. Demonstrate the use of personal protective equipment.
5. Analyze sanitary facility in work place.
6. Analyze the work related facilities and benefits.
7. Explain about safety sign in working area.

5.1.1 Introduction

Features in garment industry that could be improved to prevent injuries include; communication, involvement of employees in decision making, education and training of employees and management on prevention strategies, and the ergonomic conditions at the plant.

The clothing industry is usually considered as a safe place to work. Compared to other industries, there are fewer serious risks in clothing factories. The hazards in clothing industry are different from others. The major health risks in this industry come from more subtle hazards whose effect build up over time.

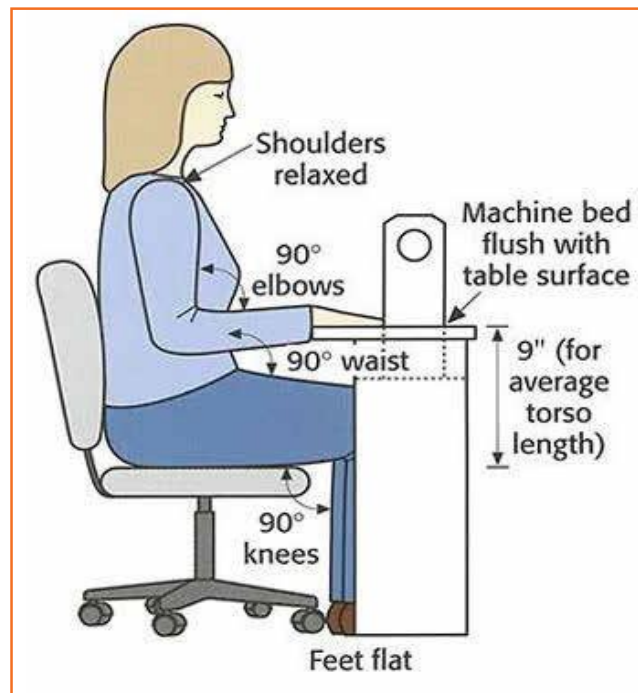

Fig.5.1.1: Body Posture

Workers in this industry face a substantially higher risk of muscle pain and injury than workers in other jobs. Studies also show that frequency of neck and shoulder injuries increases with years of employment. These injuries have a long-term effect on workers' health.

The physical requirements of a job are an important risk factor related to muscle pain and injury. The risks for Pressman have been linked to conditions such as improper work area design, including sitting arrangements.



Fig.5.1.2: Body Posture

Factors like repeated motions, force, body-posture are associated with higher risks and rate of injury. There are other factors are linked to injuries. Some of these factors include improper height of work pace, excessive workload, lack of support from co-worker, overall work environment etc. The factors that lead to reduction in injury rates include empowering workforce, following safety protocol, good housekeeping practices and increased support from top management.

5.1.2 The 'Ergonomics'

Ergonomically-designed job ensures that an employee who is tall is given a comfortable space in or near his/her workspace so that the work efficiency is not hindered. Similarly, an employee who is shorter is able to reach all of his or her tools and products without upsetting comfort and safe assortment.

Workers are usually compelled to work in the confinement of the job or workstation that previously was designed with no dynamism or change when they are hired. This leads the workforce to work in difficult postures and positions, all of which may result in work-related injuries/disorders.

The work-place related injuries often start as minor aches and pains but can develop into incapacitating injuries that affect everyday activities. Ergonomics aims at preventing injuries by monitoring the risk factors such as force, repetition, posture and vibration that can cause injuries to develop.

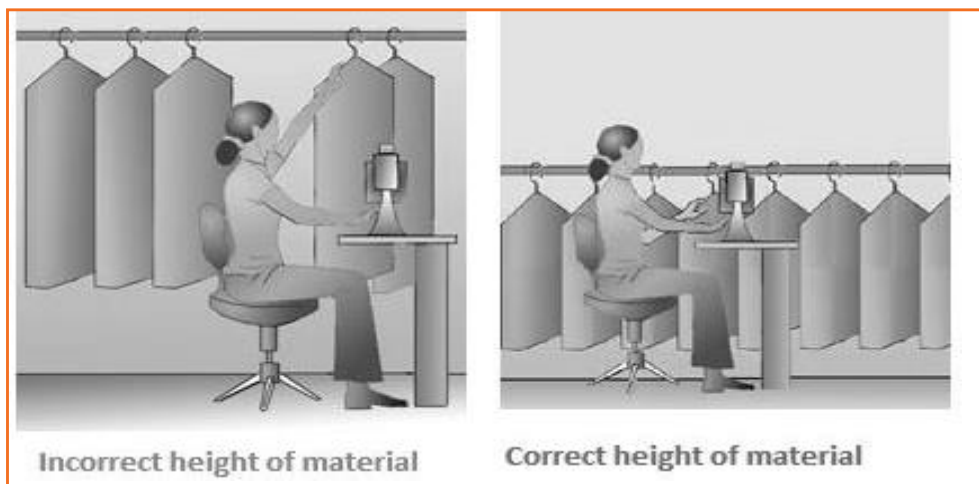

Fig.5.1.3: Situating the material

Injuries and illnesses among textile and apparel workers

- 81% complained CTDs to the wrist.
- 49% of workers is suffering from neck pains.
- 35% report obstinate lower back pain.
- 25% have suffered a compensable increasing trauma disorder.
- 14% reported CTDs to the elbow.
- 5% reported CTDs to the shoulder.
- Absenteeism increases as working conditions worsens.
- High employee turnover is associated with detrimental working conditions.
- Embroidery tasks are associated with pain in the shoulders, wrists, and hands.
- Ironing by hand is associated with elbow pain.
- Fitting fabric in frames like of work, are associated with CTDs of the hands and wrists.

Some fundamental ergonomic principals that should be followed in our workplaces are:

- **Proper tools:** Tools and equipment provided at work place should be appropriate for the specific tasks being performed. The apparatus should allow the workers to keep their hands and wrists straight – the position they would be in if they were droopy relaxed at your side. The workers should bend the tool– not the wrist. The tool should fit easily into the hand. If the grip size is too large or too small, it will be uncomfortable and will increase the risk of injury. Tools should not have sharp edges.
- **Keep repetitive motions to a minimum:** Workstations can be restructured to avoid the number of health hazards which chances due to repetitive motions that must be performed. Using a power-driven screwdriver or tools with a notch device can decrease the number of twisting motions with the arm. Work stations should have enough space for the given tasks and provide proper chairs. For deterrence of ergonomic injuries, the labour force should be encouraged to change work and take frequent but short breaks. Some tasks can be mechanical or reformatted to eliminate musculoskeletal injuries. Manufacturing tools and equipment should integrated ergonomic design codes and should not require an extreme amount of force to operate.
- **Avoid awkward postures:** The industry is such that the workforce’s job should not require you to work with your hands above shoulder height on a regular basis. Arms should be closer to the body and not raised too high. Bending of their wrists, back and neck should be avoided.
- **Use safe lifting procedures:** The employee should avoid lifting objects that are too heavy. Use more than one person or a mechanical device to reduce the load. The workstation should not require lifting objects above the head or twisting his/her back while lifting. One must keep the load close to his body. Heavy and often lifted objects should be kept between knee and shoulder height and not on the floor or above the head level.
- **Get proper rest:** It is imperative to take frequent breaks to rejuvenate the body and mind so that they don’t get injured. The workforce should be groomed to understand that they should take a break from the work not just mentally but physically too. If a person has errand which doesn’t allow him to sit, he must take intervals from his work to relax his leg muscles. If he is doing a sitting job, he must go for a walk whenever his work permits.



Fig.5.1.4: Cleaning the Tools

For example, if you stand all day, while performing your job you should sit down to rest your legs and feet during your breaks. If you sit down, when working you should stand up and walk around during your breaks to give your back a rest and to increase circulation in your legs. By doing this the musculoskeletal injuries can be prevented.

- **Other things to consider:** Chemicals also have a part in garment manufacturing. Dyes, enzymes, solvents and other chemicals are used to create different fabric finishes and provide durability to the product. Proper ventilation and personal protective equipment are important for protection of workers engaged in chemical processing. Similarly, for workers who handle the finished material and may be exposed to excess chemicals and off-gassing, protective equipment should be used.



Fig.5.1.5: Do's and Don'ts in material handling

5.1.3 Environmental Control Measures

Hazardous substances in one form or another can be found in almost all small and medium-sized enterprises. The garments industry generates a lot of dust from fabrics being cut and sewn. Some fabrics release chemicals which saturate the air causing difficulties in breathing and eye irritation. Solvents used for cleaning fabrics and garments may cause fatigue, headache and dizziness. Dust and solvents, when breathed, can lead to lung diseases and are very dangerous. Not only will this affect the well-being of your workers, it will also result in a reduction of productivity and product quality, increased absenteeism and turnover of staff. High levels of dust interfere with efficient production and require cleaning operations that may spoil materials and finished products. Improved conditions usually mean increased output, higher productivity and quality. There are simple and inexpensive ways to control most of the environmental problems. Improvements often result in cost savings, productivity benefits and increased safety of workers. The following rules provide a series of low-cost measures for sound environmental control.

5.1.3.1 Clean Regularly and Properly - Don't Spread Dust

Dust originates from fabrics and threads, from cutting and sewing to packing operations. Thus, it is very common to see small clothing enterprises with ceilings and walls full of dusty cobwebs. Even machines which are not regularly cleaned could be full of dust which may cause them to break down.

Dust increases wear and tear on machinery, necessitating more maintenance. It also negatively affects the quality of raw materials and finished products. Dust entering the respiratory system can damage the worker's lungs. Some dust can also cause allergies. Dust should be removed regularly and eliminated from the source. More comprehensive cleaning should be carried out as often as necessary. This cleaning should also include walls, ceilings, storage racks and other areas where dust accumulates. Dust on windows, walls and lamps will significantly reduce the lighting in the workplace.



Fig.5.1.6: Cleaning the Shop Floor

One low-cost cleaning method is sweeping the floor carefully with an appropriate broom and accompanying dust pan to prevent dust from spreading. Spraying water on the floor before sweeping will avoid dust remaining airborne. When dust is moistened it can be easily removed with a broom. More effective methods of controlling dust include using a vacuum cleaner or a wet mop.

5.1.4 Make Local Ventilation Cost-effective

Local ventilation should only be considered as a means of reducing chemical hazards when other means have failed. There are cost-effective ways of improving ventilation.

Use proper fans

Apart from those used for ventilating workstations, fans may be utilized to remove dangerous substances from the workplace. Contaminated air can be pushed or blown outside by having more open windows. A few points should be considered:

- There should be no obstacles between the fan and opening. Anything in the way significantly reduces the desired effect.
- The air speed should be low to reduce turbulence. In the garment industry, different fans are used; some use industrial fans or wall fans as shown in Fig. There are advantages and disadvantages for these types of fans. Industrial fans are so powerful that workers near them may be affected. Ceiling fans of the rotary type may lift the cloth being sewn, hence speed should be controlled.
- Contaminated air should not be blown in the direction of other workers on the way to the opening.



Fig.5.1.7: Using Fans

- Care should be taken that air expelled from the workplace does not affect people outside the enterprise.
- A fan may not be sufficient to remove vapours from hazardous fumes such as those sometimes used in silkscreen printing. Extractor systems to remove dust and hazardous chemicals should be installed. These systems may be quite expensive and it may be more economical to replace the hazardous chemicals.

5.1.5 Good Lighting for Quality Products

Good lighting does not mean more light bulbs and more use of electricity. Natural lighting is usually a better option than the bulbs. But if there is a difficulty in arranging for a natural lighting through windows and ventilators, its important that the bulbs and other elements of artificial lights should be well-maintained. A good lighting arrangement is directly proportionate to an efficient workforce.

80% of the absorption of information from our surroundings are from our eye as a sense organ. Bad lighting means wrong or lesser absorption of information, leading to lower productivity. Eye strain in low light can lead to head ache and again decreases the productivity level of the worker.

It is imperative to understand the ways in which we can arrange for a good lighting without increasing the electricity bills. First of all one has to identify if at all you need to work upon the existing brightness level in the work place. Lighting requirements are reliant on three main features:

- The environment of the working area
- The nature of the task
- The sharpness of the worker's eyesight

A sewer needs focused light at needle point, so needle lights should always be fitted. A worker packing garments requires more largely lighting. In many situations, packers work on special tiered work tops, where lights are built into the station. The age group of the workforce is also important factor to determine this. Which means, an older worker may need twice as much light as a younger one. Another way to identify the gap, in lighting problem is going around the workplace, observing the workers and asking them about their visual problems. The plan of improvements may not have much impact if the workers' eyesight is insufficient. An eyesight test for all employees should be carried out. Even if some workers do not follow advice about obtaining glasses. One will be aware of the problem and a possible reason for low efficiency and decreased productivity.

5.1.5.1 Use of Daylight

It is very unfortunate that many corporations undermine the fact that natural light is the best and the cheapest source of illumination. One had to gauge the surface area of the work area and measure the windows and skylights. Ideally the open space that includes the windows, ventilation windows and door should be one-third of the total area of work.

However a determinant of choosing the natural light is the heat that is emitted in the work place.



Fig.5.1.8: Use of daylight

If there is too many machinery omitting heat, it isn't a great idea to allow the natural heat to come in and add up to the temperature.

The higher the window, the more light is in. Skylights can double the light of a low light but if made in a lower level, it faces obstacles and is blocked by the machineries and storage containers. If the factory doesn't have a skylight, one must consider to replace the opaque roofs with translucent or transparent plastic rooftops.

It is important to paint the walls in lighter shades which not just give a sense of space to a room, but the workstation would look illuminated. It enhances the visual conditions and a pleasant cheerful environment is encouraged.

The matt finish of whitewash is a great idea. Many enterprises are implementing white tile ceilings. To avoid harmful glare, one should avoid gloss paint for walls. Pale colours are better than white. A slightly dimmer colour below eye level is accommodating. But one should maintain cleanliness, since lack of regular cleaning can result in the loss of at least 10 to 20 per cent of light. Special care should be taken to clean skylights, which are sometimes difficult to reach.

These colours are much better than the black formerly used for the bodies or chrome finish for the Figs, which reflect more glare. An unsatisfactory circulation of natural light over the work area, particularly in embroidery rooms, is a problem. Considering the fact, one must change the layout of benches and machines in order to minimize shadow zones. Workstations with high lighting requirements should be moved closer to the windows and possibly be assembled together for the provision of additional lighting. However, if the workstation layout

responds well to your production needs, you may instead reorganize the delivery and height of the lamps or add needle lights which are good options.



Fig.5.1.9: Sunlight in the Shop Floor

5.1.6 Reporting an Accident and an Incident

Your responsibility requires you to be aware of potential hazards and correct reporting processes. If you notice a potentially hazardous situation, eg: a client expressing violent behavior, it is important that you report it immediately to management and fill out the appropriate forms as legally required of you.

If you are injured at work you must:

- Report the injury to management as soon as possible, and certainly within 24hours.
- Seek proper treatment for your injury.

5.1.6.1 Accidents

Always work in a safe manner to prevent accidents from occurring in the first place. Make sure that you have been given adequate information and on-the-job training about the first aid facilities and services available in your workplace, including:

- Where to find first aid kits.
- Location of first aid rooms.
- Complete, up-to-date contact details of trained first aid officers in the workplace procedures for critical accidents – such as who should be responsible for calling.
- The ambulance/doctor/nurse and what is the best method of contact, measures for evacuation of the injured person/s.
- Emergency procedure for the elimination of life-threatening chemicals commonly used in the workplace.
- Universal precautions for the control of infection.
- Who to contact for debriefing/psychological support.

Reporting of incidents and accidents is required under the Work Health and Safety (WHS) legislation. Workplaces tend to have well developed reporting procedures in place, which aim to fully understand the accident/incident and prevent any future occurrences through investment in injury prevention, based upon accurate data. Reporting and recording should also facilitate costing and associated financial loss.

Always report an accident to management immediately. There should be a form at each workplace that you (or the person involved) and any witnesses can fill out, where possible, otherwise. The form should cover the following areas:

- **Description of the occurrence:** What was the event that occurred, which required this report to be completed?
- **Nature of injury or disease:** Select the most appropriate description from a range of options. What injury or disease happened as a result of the occurrence?
- **First aid, medical treatment or hospital admission:** This section asks for a description of what was done to treat the injury or disease.
- **Part of the body affected:** Tick off which part or parts of the body were affected as a result of the occurrence.
- **Source of injury:** What actually caused the person to be injured or acquire a disease? This could be a piece of machinery or other hazardous materials for example.
- **Probable cause or causes of injury:** How was the source listed above actually responsible for the injury?
- **Investigation:** This asks a series of questions that seek to find out why the person has been injured or has acquired a disease.
- **Notification checklist:** This checklist makes sure that everyone who should have been contacted regarding the matter has been contacted and asks whether appropriate action has been taken by the authorities.
- **Preventative action:** This asks whether or not any action has been taken to prevent the occurrence from happening again.
- **Witness details:** This part is to be filled out if someone saw the occurrence happen. It is essential if any sort of legal action is to be taken.

5.1.7 Mock Drills/ Evacuations

Fire safety and evacuation plans sketch staff duties and accountabilities in time of emergency. Continuing training is required to help safeguard that the employees are conscious of those duties and responsibilities. Fire fighting trainings serve as an prospect for staff members to validate, under replicated fire conditions, that they can perform those duties and responsibilities safely and efficiently. It's also a time for them to demonstration that they are aware of defend-in-place strategies and can take advantage of your facility's fire protection features and exit facilities to protect the people in their care.

Fire drills are excellent exercise designed to evaluate staff response to a replicated emergency. They are also a test of your facility's fire safety/evacuation strategies and staff training programs. It is not essential that all fire drills run smoothly. That's okay, so long as staff and the organization learns from them and correct mistakes made. It's vital, therefore, that there be a analysis of each drill so that any problems met can be addressed. Perhaps the problems are due to unfinished or outdated fire safety/emigration plans. Perhaps there's a need for additional staff training.

The two essential components of a fire preparedness plan are the following:

1. An emergency action plan, which details what to do when a fire occurs.
2. A fire prevention plan, which describes what to do to prevent a fire from occurring.



Fig.5.1.10: Fire Safety

5.1.8 Low-cost Work-related Welfare Facilities and Benefits

Work-related welfare conveniences and facilities are never given heed to. Who cares about toilets, first-aid kits, lunch rooms or lockers? What do they have to do with the hard authenticities of production? One answer is that workforces care. During each working day, workers need to drink water or some other beverage, eat meals and snacks, wash their hands, visit a lavatory, and rest to recover from fatigue. This can be difficult or easy, unpleasant or comfortable, a health risk or an aid to hygiene and nutrition. The essential facilities in the factory show if you care about employees more or the machines.

Another good reason is that extra efforts for better facilities are often appreciated far beyond the time and money capitalized, Work-related facilities benefit workers to overcome problems which are important to them. Let workers express their priorities for improvements and give their feedback. You may be surprised at the results. Giving a hygienic and wel-maintained workplace is indirectly showing yur employees how much you care for them.

A small enterprise can be a community where workers are loyal, with good industrial relations and high morale, It can also be a place where workers look for the first chance to leave and care little about the owner's success. Which kind of initiative do you want? The series of low-cost facilities that trails will help to retain the best staffs.

5.1.8.1 Essential Facilities

Drinking water

Drinking water is indispensable for all workers; if this is not provided, they become thirsty and gradually dehydrated. This greatly increases fatigue and lowers productivity, especially in a hot environment. Place water vessels near each group of workers, or provide taps or cascades with clean water in a central place. This will minimize the time lost in going to get a drink. However, drinking water should not be placed in washrooms or toilets, near dangerous machines or other hazards, nor in places where it can be contaminated by dust, chemicals or other substances.

If there is any doubt about contamination, water must be thoroughly boiled or properly filtered or treated. Unhealthy water will lead to illness and therefore absenteeism from work. Before starting to use a new water source for drinking purposes, it is advisable to have it tested to make sure it conforms to the national standard for drinking water. The design, construction and operation of deep wells for the extraction of ground water should be subjected to the provisions of existing water codes. Piped water should only be used when a hygienic water supply is guaranteed. A clear distinction between potable and non-potable water taps should be made and a "Safe Drinking Water" sign should be put up near to each tap.

Drinking water vessels should be made from materials that can easily be cleaned, Even if the vessels are filled with fresh water, the water inside, if kept for even a short time, can become unhygienic. It should therefore be different frequently. It is also imperative to make sure that drinking water is cool. If a water cooler is too luxurious, the water vessels can be placed in the coolest place in the factory. It will facilitate the water to remain cool throughout the day. They should not be left uncovered, under the sun or in a hot place. Drinking fountains for production areas are very advantageous from a hygienic point of view. They can be fitted with a jet or bubbler outlet and/or goose-neck or other outlet for filling drinking cups. The fountain should be free from sharp angles and designed to prevent unnecessary splashing. Water outlets should be above the rim of overflow level so that they will not be contaminated with waste water. The water outlet should be shielded to prevent the lips of a drinker from being placed on it. Drinking water containers should be attended by a designated person. Containers should be made of impermeable materials. A cooling device would be an advantage. (Unglazed pottery can be used, due to its unique cooling effect, in dust-free places.) Containers should be provided with suitable covers, and kept in a cool place protected from the sun. The water must be changed frequently.

To avoid the possible spread of infection, it is better to use throwaway cups or to provide separate cups for each worker and to arrange for regular washing. When containers are used, it is important to clean them regularly. Cleaning and other necessary conservation tasks should be assigned to a specific person. In addition, the provision of a competence for boiling water will enable people to make coffee or other hot beverage during breaks. Hot water is required if the enterprise has a childcare facility.

5.1.5.2 Sanitary Facilities

There are several reasons why the provision of washing facilities is important:

- Dirt and grime can be ingested and cause sickness or disease; they are, in any case, unpleasant and demoralizing.
- Washing is a necessity when women have their monthly periods.
- Washing is required for basic hygiene after using the toilet.
- Apart from the obvious basic need, sanitary facilities are required by law. Clienteles often create an impression of an enterprise through the quality of its sanitary facilities.

- There should be a sufficient number of hygienic facilities on the work locations and each should be conveniently located to avoid long walks, waiting and hindrance. The law of the country must be monitored, but the following are the minimum requirements:
- One restroom is required for up to five men; two toilets for six to 40 men.
- One separate restroom for up to five women and two toilets for six to 30 women.
- One wash-basin for every 15 workers.



Fig.5.1.11: Signages

Ideally, there would be a separate toilet for men and women. These should be characterized as follows:

- The toilet bowl must be free from stain or odour and function properly.
- The walls of the toilet must be clean and tiles unstained.
- The ceiling of the toilet must be free from cobwebs and dust.
- Floors must be clean and safe (no broken tiles, nor slippery surface).
- Proper illumination must be provided inside the toilet.
- Toilets must have a continuous supply of water; in case water is limited in the area, water should be stocked in containers and refilled regularly.
- Mirrors and rubbish bins should be provided in the washroom.
- Soap and toilet paper should be provided.
- The washroom should provide complete privacy to users and should be fully ventilated.

5.1.9 Be Ready for Emergencies

Misfortunes can happen even if proper defensive measures are installed. So, always be prepared for emergencies and have readiness for disaster management, like cuts and bruises, eye injuries, burns, poisoning and electric shocks. Every enterprise should maintain a well-stocked first-aid box and assign at least one person from every shift to handle emergencies. First-aid boxes should be clearly marked and situated in a place, so that they are readily reachable in an emergency. They should not be more than 100 metres away from any place on the work site. Ideally, such kits should be near a wash-basin and in good lighting conditions. Their supplies need to be regularly checked and replenished. The contents of a first-aid box are often regulated by law, with variations according to the size and the likely industrial hazards of the enterprise. A typical basic kit may include the following items in a dustproof and waterproof box:

- Sterile bandages, pressure bandages, dressings (gauze pads) and slings. These should be individually wrapped and placed in a dustproof box or bag. Adequate quantities of the different sizes should be available at all times to treat small cuts and burns.
- Cotton wool for cleaning wounds.



Fig.5.1.12: First Aid

Ideally, there would be a separate toilet for men and women. These should be characterized as follows:

- The toilet bowl must be free from stain or odour and utility properly.
- The walls of the toilet must be clean and tiles unstained.
- The ceiling of the toilet must be free from torpors and dust.
- Floors must be clean and safe (no broken tiles, nor slippery surface).
- Proper illumination must be provided inside the restroom.
- Lavatories must have a continuous supply of water; in case water is limited in the area, water should be stocked in containers and refilled regularly.
- Mirrors and rubbish bins should be provided in the washroom.
- Soap and toilet paper should be provided.
- The washroom should give complete privacy to users and should be fully aired.

5.1.10 Safety Signs at Workplace

Safety Signs: Sign providing information or instruction about safety or health at work by means of a signboard, a colour, an illuminated sign or acoustic signal, a verbal communication or hand signal.

Signboard: A sign which provides information or instructions by a combination of shape, colour and a symbol or pictogram which is rendered visible by lighting of sufficient intensity. In practice, many signboards may be accompanied by supplementary text, eg 'Fire exit', alongside the symbol of a moving person. Signboards can be of the following four types:

1. **Prohibition sign:** A sign prohibiting behaviour likely to increase or cause danger (eg 'no access for unauthorised persons').



Fig.5.1.13: Prohibition sign

2. **Warning sign:** A sign giving warning of a hazard or danger (eg 'danger: electricity').



Fig.5.1.14: Warning sign

3. **Mandatory sign:** A sign prescribing specific behaviour (eg 'eye protection must be worn').



Fig.5.1.15: Mandatory sign

4. **Emergency escape, Fire and First-aid signs:** A sign giving information on emergency exits, first aid, or rescue facilities (eg 'emergency exit/escape route').

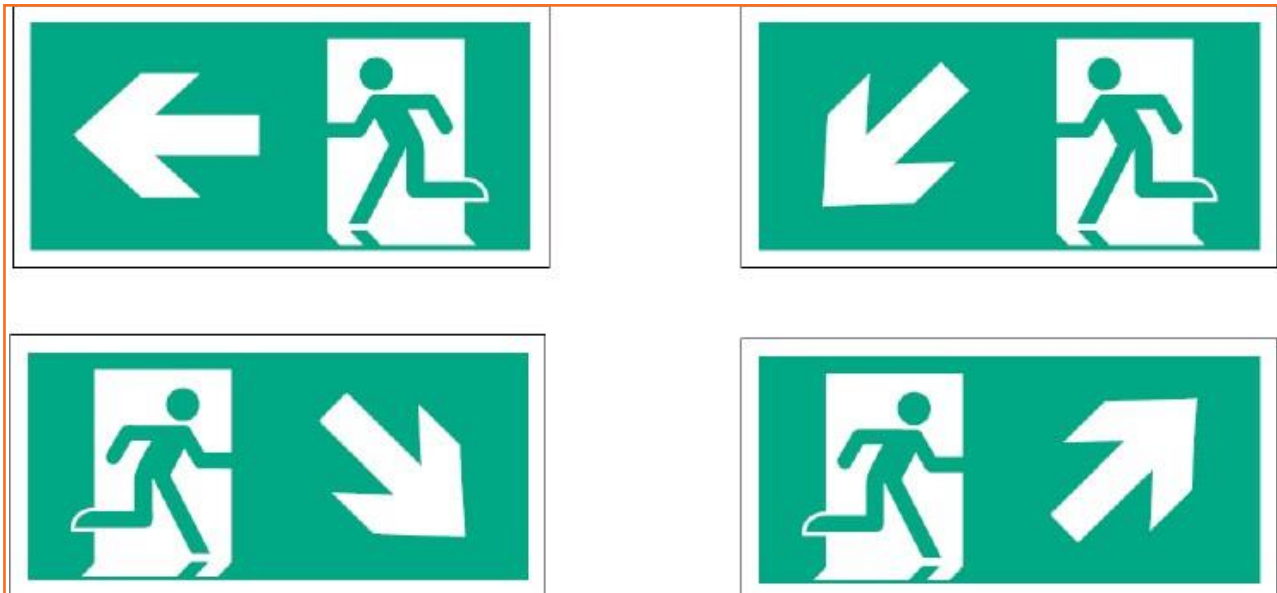

Fig.5.1.16: Emergency escape

Signs for emergency exits



Fig.5.1.17: Signs for emergency exits

Signs for Fire and First Aid



Fig.5.1.18: Signs for Fire

5.1.11 Prevention and Management of Corona Virus

As we all know a new respiratory disease called COVID-19 is spreading across the world. India has also reported cases from states and the government is trying to contain the spread of the disease. We can play a major role in preventing its spread by follow Covid safety guidelines.

COVID-19 is a disease caused by the “novel corona virus”. Common symptoms are Fever, Dry cough, Breathing difficulty, Some patients also have aches and pains, nasal congestion, runny nose, sore throat or diarrhea



Fig.5.1.19: Prevention from COVID-19

COVID-19 spreads mainly by droplets produced as a result of coughing or sneezing of a COVID-19 infected person. To protect yourself from Covid-19, follow below guidelines.

- Maintain a safe distance from others (at least 1 metre), even if they don't appear to be sick.
- Wear a mask in public, especially indoors or when physical distancing is not possible.
- Choose open, well-ventilated spaces over closed ones. Open a window if indoors.
- Clean your hands often. Use soap and water, or an alcohol-based hand rub.
- Get vaccinated when it's your turn. Follow local guidance about vaccination.
- Cover your nose and mouth with your bent elbow or a tissue when you cough or sneeze.
- Stay home if you feel unwell.
- If you have a fever, cough and difficulty breathing, seek medical attention. Call in advance so your healthcare provider can direct you to the right health facility.

This protects you, and prevents the spread of viruses and other infections.

Exercise

1. While working at workplace, your waist should be at:
 - a) 300
 - b) 600
 - c) 900
 - d) 1200
1. We receive _____ per cent of all information through our eyes.
 - a) 75%
 - b) 60%
 - c) 70%
 - d) 80%
2. In case of fire do not use _____.
 - a) Lift
 - b) Stairs
 - c) Ladder
 - d) Window
3. The factors that lead to reduction in injury rates include:
 - a) Empowering workforce
 - b) Following safety protocol
 - c) Good housekeeping practices
 - d) Support from top management
 - e) All of the above
4. Lighting requirements are reliant on:
 - a) The environment of the working area
 - b) The nature of the task
 - c) The sharpness of the worker's eyesight
 - d) All of the above

UNIT 5.2: First Aid & CPR

Unit Objectives

At the end of this unit, participants will be able to:

1. Apply first aid on an injured person.
2. Interpret the procedure of CPR.

5.2.1 First Aid

First aid is the assistance given to any person suffering a sudden illness or injury, with care provided to preserve life, prevent the condition from worsening, and/or promote recovery. It includes initial intervention in a serious condition prior to professional medical help being available, such as performing CPR while awaiting an ambulance, as well as the complete treatment of minor conditions, such as applying a plaster to a cut. First aid is generally performed by the layperson, with many people trained in providing basic levels of first aid, and others willing to do so from acquired knowledge. Mental health first aid is an extension of the concept of first aid to cover mental health.



Fig.5.2.1: First aid Pyramid

There are many situations which may require first aid, and many countries have legislation, regulation, or guidance which specifies a minimum level of first aid provision in certain circumstances. This can include specific training or equipment to be available in the workplace (such as an Automated External Defibrillator), the provision of specialist first aid cover at public gatherings, or mandatory first aid training within schools. First aid, however, does not necessarily require any particular equipment or prior knowledge, and can involve improvisation with materials available at the time, often by untrained persons.

Vital Signs	Good	Poor
Heart Rate	60-100 beats per minute	Less than 60 or greater than 100 beats per minute
Respirations	14-16 breaths per minute	Less than 14 breaths per minute
Skin	Warm, pink and dry	Cool, pale and moist
Consciousness	Alert and orientated	Drowsy or unconscious

Fig.5.2.2: Vital Signs

Awareness	Assessment	Action	Aftercare
<ul style="list-style-type: none"> Observe Stop to Help 	<ul style="list-style-type: none"> Assess what is required to be done Ask yourself, 'Can I do it?' 	<ul style="list-style-type: none"> Do what you can Call for expert medical help Take care of your and the bystander's safety 	<ul style="list-style-type: none"> Once you have assisted the victim, stay with him/her till expert care arrives

Fig.5.2.3: Four A's of First Aid

While delivering First Aid always remember:

- Prevent deterioration.
- Act swiftly, deliberately and confidently.
- Golden Hour – First 60 minutes following an accident.
- Platinum Period – First 15 minutes following an accident.
- Prevent shock and choking.
- Stop bleeding.
- Loosen victim's clothes.
- Regulate respiratory system.
- Avoid crowding/over-crowding.
- Arrange to take victim to safe place/hospital.
- Attend to emergencies first with ease and without fear.
- Do not overdo. Remember that the person giving first aid is not a doctor.

Injury	Symptom	Do's	Don'ts
Fracture	<ul style="list-style-type: none"> Pain Swelling Visible bone 	<ul style="list-style-type: none"> Immobilise the affected part Stabilise the affected part Use a cloth as a sling Use board as a sling Carefully Transfer the victim on a stretcher 	<ul style="list-style-type: none"> Do not move the affected part Do not wash or probe the injured area
Burns (see Degrees of Burn table)	<ul style="list-style-type: none"> Redness of skin Blistered skin Injury marks Headache/seizures 	<ul style="list-style-type: none"> In case of electrical burn, cut-off the power supply In case of fire, put out fire with blanket/coat Use water to douse the flames Remove any jewellery from the affected area Wash the burn with water 	<ul style="list-style-type: none"> Do not pull off any clothing stuck to the burnt skin Do not place ice on the burn Do not use cotton to cover the burn

Bleeding	<ul style="list-style-type: none"> • Bruises • Visible blood loss from body • Coughing blood • Wound/Injury marks • Unconsciousness due to blood loss • Dizziness • Pale skin 	<ul style="list-style-type: none"> • Check victim's breathing • Elevate the wound above heart level • Apply direct pressure to the wound with a clean cloth or hands • Remove any visible objects from the wounds • Apply bandage once the bleeding stops 	<ul style="list-style-type: none"> • Do not clean the wound from out to in direction • Do not apply too much pressure (not more than 15 mins) • Do not give water to the victim
Heat Stroke/Sun Stoke	<ul style="list-style-type: none"> • High body temperature • Headache • Hot and dry skin • Nausea/Vomiting • Unconsciousness 	<ul style="list-style-type: none"> • Move the victim to a cool, shady place • Wet the victim's skin with a sponge • If possible apply ice packs to victim's neck, back and armpits • Remove any jewellery from the affected area • Wash the burn with water 	<ul style="list-style-type: none"> • Do not let people crowd around the victim • Do not give any hot drinks to the victim
Unconsciousness	<ul style="list-style-type: none"> • No movement of limbs • No verbal response or gestures • Pale skin 	<ul style="list-style-type: none"> • Loosen clothing around neck, waist and chest • Check for breathing • Place the victim's legs above the level of heart • If victim is not breathing, perform CPR 	<ul style="list-style-type: none"> • Do not throw water or slap the victim • Do not force feed anything • Do not raise the head high as it may block the airway

Fig.5.2.4: First Aid for different types of injuries

1st Degree Burn	2nd Degree Burn	3rd Degree Burn	4th Degree Burn
Will recover itself in a few days. Action Required: Place under running water.	Serious but recovers in a few weeks. Action Required: Place clean wet cloth over the burnt area.	Very Serious and will require skin grafting. Action Required: Place a clean dry cloth over the burnt area.	Extremely Serious and requires many years with repeated plastic surgery and skin grafting, is life threatening. Action Required: Leave open and prevent infection.

Fig.5.2.5: Degree of Burns

5.2.2 Splints and Aids of Torso

A splint is a bandage that immobilizes a broken bone. Sometimes this is done by using rigid objects such as sticks or boards. For some injuries, however, this isn't possible and the only option is to tie the broken limb to the body.

5.2.2.1 Splints

During the application of a splint, it is important to not attempt to straighten the break. This will lead to more injury and pain for the affected. Instead, the splint should be applied to the break the way it was.

When using rigid material

Always use long enough pieces to reach the joints beyond the break. For example, when splinting a forearm, the material should be long enough to touch both the wrist and the elbow. This helps keep the material in place and prevents too much pressure from being applied to the wound.

- Always put padding between the rigid material and the body to keep the victim comfortable.
- Knots should be tied between the body and the rigid material. This is an easier option when it comes to untying them. However, if this can't be carried out, the knots should be tied over the rigid material.
- Padding should always be used between the body and the rigid material in order to provide a comfortable setting to the affected.



Fig.5.2.6: Splint the Forearm

- Splint the wrist in the same way. The entire forearm should be immobilized.



Fig.5.2.7: splint the Wrist

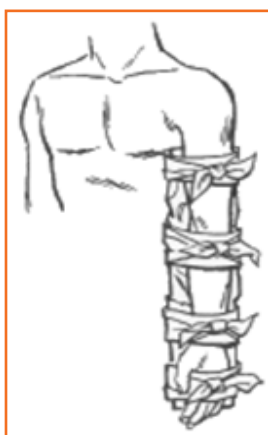

Fig.5.2.8: Splint the Elbow

- To splint the elbow, use enough rigid material to go from the armpit to the hand. The entire arm should be immobilized. Do not attempt to straighten or bend the elbow; splint it in position.
- To splint the upper leg, use long pieces of rigid material that will reach from the ankle to the armpit. Above the hips, tie long straps around the torso to hold the top of the splint in place.



Fig.5.2.9: Splint the Upper Leg

- The pieces used should be long enough to reach the joint beyond the break. For instance, when a forearm is splinted, the material should be long enough in such a way that it includes both the wrist and the elbow. This helps in preventing too much pressure to the wound and also helps in keeping the material in place.



Fig.5.2.10: Splint the Lower Leg

5.2.3 CPR

Basic life support (BLS) is a level of medical care which is used for victims of life-threatening illnesses or injuries until they can be given full medical care at a hospital.

First aid is as easy as ABC – airway, breathing and CPR (cardiopulmonary resuscitation). In any situation, apply the DRSABCD Action Plan.

DRSABCD stands for:

- **Danger:** Always check the danger to you, any bystanders and then the injured or ill person. Make sure you do not put yourself in danger when going to the assistance of another person.
- **Response:** Is the person conscious? Do they respond when you talk to them, touch their hands or squeeze their shoulder?
- **Send for help:** Call ambulance.
- **Airway:** Is the person's airway clear? Is the person breathing? If the person is responding, they are conscious and their airway is clear, assess how you can help them with any injury.



Fig.5.2.11: Basic life support chart

If the person is not responding and they are unconscious, you need to check their airway by opening their mouth and having a look inside. If their mouth is clear, tilt their head gently back (by lifting their chin) and check for breathing. If the mouth is not clear, place the person on their side, open their mouth and clear the contents, then tilt the head back and check for breathing.

- **Breathing:** Check for breathing by looking for chest movements (up and down). Listen by putting your ear near to their mouth and nose. Feel for breathing by putting your hand on the lower part of their chest. If the person is unconscious but breathing, turn them onto their side, carefully ensuring that you keep their head, neck and spine in alignment. Monitor their breathing until you hand over to the ambulance officers.
- **CPR (cardiopulmonary resuscitation):** if an adult is unconscious and not breathing, make sure they are flat on their back and then place the heel of one hand in the centre of their chest and your other hand on top. Press down firmly and smoothly (compressing to one third of their chest depth) 30 times. Give two breaths. To get the breath in, tilt their head back gently by lifting their chin. Pinch their nostrils closed, place your open mouth firmly over their open mouth and blow firmly into their mouth. Keep going with the 30 compressions and two breaths at the speed of approximately five repeats in two minutes until you hand over to the ambulance officers or another trained person, or until the person you are resuscitating responds.
- **Defibrillator:** For unconscious adults who are not breathing, an automated external defibrillator (AED) is applied. An AED is a machine that delivers an electrical shock to cancel any irregular heart beat (arrhythmia), in an effort get the normal heart beating to re-establish itself. Please ensure that a trained person is there

to apply the AED. If the person responds to defibrillation, turn them onto their side and tilt their head to maintain their airway.

1. Airway

Once you have assessed the patient’s level of consciousness, evaluate the patient’s airway. Remember, if the patient is alert and talking, the airway is open. For a patient who is unresponsive, make sure that he or she is in a supine (face-up) position to effectively evaluate the airway. If the patient is face-down, you must roll the patient onto his or her back, taking care not to create or worsen an injury. If the patient is unresponsive and his or her airway is not open, you need to open the airway. Head-tilt/chin-lift technique can be used to open the airway.

Head-tilt/chin-lift technique

To perform the head-tilt/chin lift technique on an adult:

- Press down on the forehead while pulling up on the bony part of the chin with two to three fingers of the other hand.
- Tilt the head past a neutral position to open the airway while avoiding hyperextension of the neck.

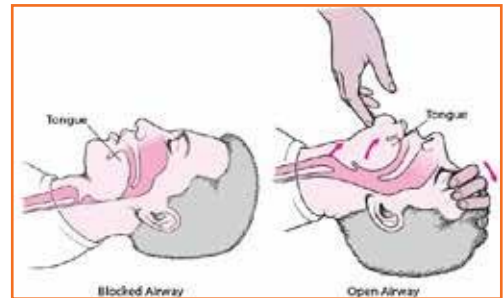

Fig.5.2.12: Airway

2. Cardiopulmonary resuscitation

Cardiopulmonary resuscitation circulates blood that contains oxygen to the vital organs of a patient in cardiac arrest when the heart and breathing have stopped. It includes chest compressions and ventilations as well as the use of an automated external defibrillator.



Fig.5.2.13: CAB

- **Compressions:** One component of CPR is chest compressions. To ensure optimal patient outcomes, high-quality CPR must be performed. You can ensure high-quality CPR by providing high-quality chest compressions, making sure that the:

- » Patient is on a firm, flat surface to allow for adequate compression. In a non- healthcare setting this would typically be on the floor or ground, while in a healthcare setting this may be on a stretcher or bed.
- » The chest is exposed to ensure proper hand placement and the ability to visualize chest recoil.
- » Hands are correctly positioned with the heel of one hand in the center of the chest on the lower half of sternum with the other hand on top. Most rescuers find that interlacing their fingers makes it easier to provide compressions while keeping the fingers off the chest.

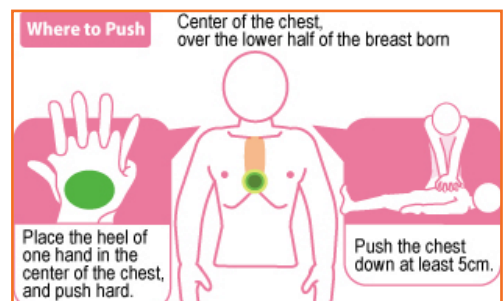

Fig.5.2.14: Compressions

- » Arms are as straight as possible, with the shoulders directly over the hands to promote effective compressions. Locking elbows will help maintain straight arms.
- » Compressions are given at the correct rate of at least 100 per minute to a maximum of 120 per minute, and at the proper depth of at least 2 inches for an adult to promote adequate circulation.
- » The chest must be allowed to fully recoil between each compression to allow blood to flow back into the heart following the compression.
- » For adult co-workers, CPR consists of 30 chest compressions followed by 2 ventilations.
- **Ventilations:** Ventilations supply oxygen to a patient who is not breathing. They may be given via several methods including:

Mouth-to-Mouth

- Open the airway past a neutral position using the head-tilt/chin-lift technique.
- Pinch the nose shut and make a complete seal over the patient's mouth with your mouth.
- Give ventilations by blowing into the patient's mouth. Ventilations should be given one at a time. Take a break between breaths by breaking the seal slightly between ventilations and then taking a breath before re-sealing over the mouth.

Pocket mask

CPR breathing barriers, such as pocket masks, create a barrier between your mouth and the patient's mouth and nose. This barrier can help to protect you from contact with a patient's blood, vomitus and saliva, and from breathing the air that the patient exhales.

- Assemble the mask and valve.
- Open the airway past the neutral position using the head-tilt/chin-lift technique from the patient's side when alone.
- Place the mask over the mouth and nose of the patient starting from the bridge of the nose, then place the bottom of the mask below the mouth to the chin (the mask should not extend past the chin).
- Seal the mask by placing the "webbing" between your index finger and thumb on the top of the mask above the valve while placing your remaining fingers on the side of the patient's face. With your other hand (the hand closest to the patient's chest), place your thumb along the base of the mask while placing your bent index finger under the patient's chin, lifting the face into the mask.

5.2.4 Performing CPR for an Adult

- **STEP 1: Check the scene for immediate danger:** Make sure that you are not compromising your own safety by administering CPR to someone else. Is there a fire? Is the person lying on a roadway? It is important to do whatever is necessary to move yourself and carry the other person to safety.
- **STEP 2: Assess the victim's consciousness:** Gently tap his or her on their shoulder and ask, "Are you OK?" If the person responds in affirmative in a loud or clear voice, CPR is not required. Instead, one should undertake basic first aid and take measures to prevent or treat shock and assess whether there is a need to contact emergency services. If the victim is not responsive, the following steps should be undertaken.
- **STEP 3: Do not check for a pulse:** Unless you're a trained medical professional, odds are you'll spend too much valuable time looking for a pulse when you should be doing compressions.

- **STEP 4: Check for breathing:** Make sure that the airway is not blocked. If the mouth is closed, press with your thumb and forefinger on both cheeks at the end of the teeth and then look inside. Remove any visible obstacle that is in your reach but never push your fingers inside too far. Put your ear close to the victim's nose and mouth, and listen for slight breathing. If the victim is coughing or breathing normally, do not perform CPR.



Fig.5.2.15(a): Performing CPR for an Adult

- **STEP 5: Place the victim on his or her back:** Make sure he or she is lying as flat as possible-this will prevent injury while you're doing chest compressions. Tilt their head back by using your palm against their forehead and a push against their chin.



Fig.5.2.15(b): Performing CPR for an Adult

- **STEP 6:** Place the heel of one hand on the victim's breastbone, 2 finger-widths above the meeting area of the lower ribs, exactly in the middle of the chest.



Fig.5.2.15(c): Performing CPR for an Adult

- **STEP 7:** Place your second hand on top of the first hand, Palms-down, interlock the fingers of the second hand between the first.



Fig.5.2.15(d): Performing CPR for an Adult

- **STEP 8:** Position your body directly over your hands, so that your arms are straight and somewhat rigid. Don't flex the arms to push, but sort of lock your elbows, and use your upper body strength to push.



Fig.5.2.15(e): Performing CPR for an Adult

- **STEP 9:** Perform 30 chest compressions. Press down with both hands directly over the breastbone to perform a compression, which helps the heart beat. Chest compressions are more critical for correcting abnormal heart rhythms (ventricular fibrillation or pulseless ventricular tachycardia, heart rapidly quivering instead of beating). You should press down by about 2 inches (5 cm).



Fig.5.2.15(f): Performing CPR for an Adult

- **STEP 10:** Minimize pauses in chest compression that occur when changing providers or preparing for a shock. Attempt to limit interruptions to less than 10 seconds.



Fig.5.2.15(g): Performing CPR for an Adult

- **STEP 11:** Make sure the airway is open. Place your hand on the victim's forehead and two fingers on their chin and tilt the head back to open the airway. If you suspect a neck injury, pull the jaw forward rather than lifting the chin. If jaw thrust fails to open the airway, do a careful head tilt and chin lift. If there are no signs of life, place a breathing barrier (if available) over the victim's mouth.



Fig.5.2.15(h): Performing CPR for an Adult

- **STEP 12:** Give two rescue breaths (optional). If you are trained in CPR and totally confident, give two rescue breaths after your 30 chest compressions. If you've never done CPR before, or you're trained but rusty, stick with only chest compressions.



Fig.5.2.15(i): Performing CPR for an Adult

- **STEP 13:** Repeat the cycle of 30 chest compressions. If you're also doing rescue breaths, keep doing a cycle of 30 chest compressions, and then 2 rescue breaths; repeat the 30 compressions and 2 more breaths. You should do CPR for 2 minutes (5 cycles of compressions to breaths) before spend time checking for signs of life.

5.2.5 CPR Using AED

- **STEP 1:** Use an AED (automated external defibrillator). If an AED is available in the immediate area, use it as soon as possible to jump-start the victim's heart. Make sure there are no puddles or standing water in the immediate area.



Fig.5.2.16(a): Performing CPR for an Adult

- **STEP 2:** Fully expose the victim's chest. Remove any metal necklaces or underwire bras. Check for any body piercings, or evidence that the victim has a pacemaker or implantable cardioverter defibrillator (should be indicated by a medical bracelet) to avoid shocking too close to those spots. Make sure the chest is absolutely dry and the victim is not in a puddle. Note that, if the person has a lot of chest hair, you may need to shave it, if possible. Some AED kits come with razors for this purpose.



Fig.5.2.16(b): Performing CPR for an Adult

- **STEP 2:** Attach the sticky pads with electrodes to the victim's chest. Follow the instructions on the AED for placement. Move the pads at least 1 inch (2.5 cm) away from any metal piercings or implanted devices. Make sure no one is touching the person, when you apply the shock.



Fig.5.2.16(c): Performing CPR for an Adult

- **STEP 8:** Press analyse on the AED machine. If a shock is needed for the patient, the machine will notify you. If you do shock the victim, make sure no one is touching him or her.
- **STEP 9:** Do not remove pads from the victim and resume CPR for another 5 cycles before using the AED again. Stick on adhesive electrode pads are intended to be left in place.

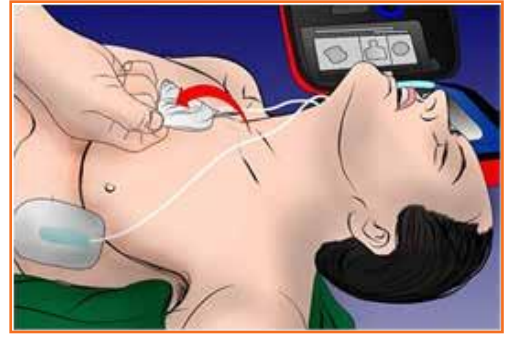

Fig.5.2.16(d): Performing CPR for an Adult

5.2.6 Chain of Survival

Chain of Survival is a sequential process for providing treatment to victims of SCA outside of a hospital setting. More people can survive SCA if the following steps occur in rapid succession:

- Cardiac arrest is immediately recognized and the emergency response system is activated.
- Early cardiopulmonary resuscitation (CPR) is started with an emphasis on chest compression.
- Rapid defibrillation occurs.
- Effective advanced life support is begun.
- Integrated post-cardiac arrest care is provided.
- Quick execution of each step is critical because the chances of survival decrease 7 to 10 percent with each passing minute.

UNIT: 5.3: Sensitivity towards People with disability and Gender Equality

Unit Objectives

At the end of this unit, participants will be able to:

1. Elaborate the details about PWD Sensitization.
2. Explain gender sensitization and equality.

5.3.1 What is sensitization?

The process of becoming highly sensitive to specific events or situations (especially emotional events or situations) Sensitization doesn't always mean feeling the same pain the other person is feeling. It means knowing that the pain exists and there is a different way of living. Despite how the person lives, he or she has a right to exist in a society. It's an attitudinal change and very much required in current time.

Sensitivity to People with Disability

According to the Oxford Dictionary, a disability could be described as an impairment which can be Intellectual, limitations, cognitive, improvement, sensory, exercise or the mixture of all these. Incapacity impacts a person's activities and may happen at birth. Sometimes, it could happen in adulthood. In the medical model, individuals with certain physical, intellectual, psychological and mental impairments are taken as disabled. According to this, the disability lies in the individual as it is equated with restrictions of activity with the burden of adjusting with environment through cures, treatment and rehabilitation.

People with disabilities are subject to multiple deprivations with limited access to basic services, including education, employment, rehabilitation facilities etc. To work towards an inclusive, barrier free society by raising awareness and policy actions, there is a need to have comprehensive reliable statistics on people with disability and their socio-economic conditions

The Constitution of India ensures equality, freedom, justice and dignity of all individuals including persons with disabilities and mandates an inclusive society for all.

The Persons with Disabilities (Equal Opportunities, Protection of Rights and Full Participation Act, 1995) came into force on February 7, 1996. This was an important landmark and was a significant step in the direction of ensuring equal opportunities for persons with disabilities and their full participation in the nation building. The Act provides for both preventive and promotional aspects of rehabilitation like education, employment and vocational training, job reservation, research and manpower development, creation of barrier-free environment, rehabilitation of person with disability, unemployment allowance for the disabled, special insurance scheme for the disabled employees and establishment of homes for persons with severe disability etc.

In order to give focused attention to Policy issues and meaningful thrust to the activities aimed at welfare and empowerment of the Persons with Disabilities, a separate Department of Empowerment of Persons with Disabilities (Divyangjan) (DEPwD) under Ministry of Social Justice & Empowerment was set up in May 2012.

Empowerment of persons with disabilities is an inter-disciplinary process, covering various aspects namely, prevention, early detection, intervention, education, health, vocational training, rehabilitation and social integration.

The disability community is very diverse. Some individuals with a disability may be employed, while others may rely on public benefits as their main sources of income. Some of the public benefits they receive might have limitations. Income, resource and savings limits often prevent individuals from enhancing their financial wellbeing and self-sufficiency as they concentrate efforts on retaining their benefits

Rather than charities, disabled people need sensitivity of the society and initiatives to make their life easy.. New and existing programs are available to help people with disabilities develop skills in financial management and self-sufficiency. Government keeps trying to support in every possible manner so that they can earn their livelihood.

We learn so many virtues from disabled people like patience, courage, positive thinking etc .Hence; this gives us all the more reasons to have a developmental approach towards them. With so many technological breakthroughs happening all over the world, the Governments have spent in Research and development and innovations which would make the life of disabled people happier and easier.

For example, the invention of artificial limbs caused a revolution. They are available to the most disabled people and they can reap benefits from them.

Also, educating them and giving them jobs based upon their physical condition will make them feel a “sense of achievement” and increase their happiness quotient.

Also, disabled people should be trained by specialists in their fields so that they can try and overcome their shortcomings to the maximum extent possible and lead a life which is satisfactory and happy.

5.3.1.1 Myths and Stereotypes

We are all individuals with commonalities and differences and that is true for persons with disabilities as well. As an instructor, it is important to remember to not show pity or put an individual up on a pedestal – everyone should be treated as equals regardless of one’s abilities. When working with people with disabilities, it is important to avoid stereotypes. To debunk common stereotypes and myths, below are some key items to note about persons with disabilities:

- Persons with disabilities are all ages, come from diverse cultures and financial backgrounds.
- People with disabilities work.
- People with disabilities have families.
- Not all persons with disabilities are on or receive benefits such as ESI, Medicaid, etc.
- People with disabilities have goals and dreams.
- All people with disabilities do not necessarily want or need assistance.
- People who are blind or have low vision may wear glasses.
- People who are deaf may use their voice and may be able to read lips, but not all.
- Not all people who use wheelchairs are completely paralyzed – some may be able to walk short distances.
- Delayed or slow speech is not necessarily a sign of a slowed mental process.
- Persons with learning disabilities can be highly intelligent individuals; they simply have a different way of learning.

5.3.1.2 People's first language

Positive language empowers people and helps them feel respected and important. When writing or speaking about people who have a disability, it is important to put the person first, usually addressing them by name or including them as a member of a group, such as a student or co-worker. Group designations such as “the blind,” “the retarded” or “the disabled” are inappropriate because they do not reflect the individuality, equality or dignity of people with disabilities.

Here are some general tips to keep in mind:

- **Offer to shake hands when introduced.** People with limited hand use or an artificial limb can usually shake hands and offering the left hand is an acceptable greeting.
- **Treat adults as adults!** Address people with disabilities by their first names only when extending that same familiarity to all others.
- **Ask First.** If you offer assistance (always ask before assisting someone), then wait until the offer is accepted. Then ask the individual with a disability for instructions on how you may assist them.
- **Relax.** Don't be embarrassed if you happen to use common expressions such as, “See you later” or “Did you hear about this?”, that seem to relate to a person's disability
- **Give them respect** as any other individual.

5.3.2 Gender Sensitization

What is Gender?

The socially constructed and culturally defined roles, responsibilities, attributes, and entitlements assigned to people based on their sex assigned at birth in a given setting, along with the power relations between and among the assigned groups.

Gender equality is the concept that all human beings, irrespective of their sex or gender identity, are free to develop their personal abilities and make choices without the limitations set by stereotypes, rigid gender roles, or discrimination.

What is Gender Bias?

- Gender bias is the tendency to make decisions or take actions based on preconceived notions of capability according to gender. People with disabilities have families.
- Not all persons with disabilities are on or receive benefits such as ESI, Medicaid, etc

It is the process of raising awareness and inculcating empathy about one's own and the other gender. Since one of the most common area of discrimination is based on gender, there is a great need to sensitize the youth on gender related issues. This would strongly contribute in ensuring that equal roles, responsibilities, opportunities, and expectations are assigned to both men and women. Training on gender sensitization will help break the stereotypes around job roles, women's participation in particular trades, and would support in equal participation of men and women in the decision-making process.

5.3.2.1 Why is the Need for Gender Sensitivity

Couple communication and decision-making

The role of men and women in household decisions about finances, food consumption, childcare, healthcare or travel often reflect power relations in the home. When power relations are unequal, it results in not only

one sided biased decision but also can increase risky sexual behavior and intimate partner violence. While it is important for women to play a larger role in important household decisions, such as financing, men should also become more involved in healthcare and household decisions around health. Couple communication and joint decision-making have a positive impact on health outcomes.

Access to opportunities and resources

Gender-related factors also affect health outcomes through differential access to opportunities and resources like education, employment and healthcare.

- **Education:** Gender roles often restrict both boys' and girls' access to education which can have long-term effects on health outcomes. For example, more educated women and formally employed women are more likely to use family planning, which reduces the risk of unwanted pregnancy and potentially, the need for abortion
- **Employment:** In many contexts, women's traditional responsibilities are primarily domestic and they do not work outside the home. When they do, they are often part of the informal economy, in lower-paid and less-skilled jobs without opportunities to join unions or trade organizations that advocate for better pay or rights
- **Healthcare:** Women's mobility may limit their access to health services and existing programs intended to increase knowledge of family planning or other health information. Men often do not go to health clinics for their own care or with their partner because pregnancy and child health are seen as a "woman's domain."

Social, cultural and gender norms

Norms related to gender, such as gender preference, masculinity and fertility, also influence health outcomes.

- **Gender Preference:** In India, China, and to a certain extent in some African countries, there is a gender bias in child healthcare. Preference for boys can lead to financial resources for education and other services, like healthcare, being differentially allocated within households. Reasons for this preference vary, and include the perception that boys will financially support their parents when they are older, and that families are obliged to pay dowries when their daughters marry.
- **Fertility:** In many areas, a woman's value is often measured by her ability to have children. This can lead women to put their own health or the health of their family at risk by starting pregnancy too early, when not yet physically matured, and giving birth without proper spacing or having more children than the household can support. For couples facing fertility issues, women often bear the brunt of household and community-level stigma and abuse for failing to conceive.
- **Masculinity:** Masculine ideas associating men with strength, virility, dominance and power may increase the number of sexual partners and inhibit the use of condoms, thereby increasing the risk for unwanted pregnancy or the transmission of STIs or HIV through unprotected sex or sexual violence. These masculine norms also may promote or normalize violence against women

Summary of Need for Gender Sensitization

- To provide balance to the society
- To provide equal opportunities to women and men
- To gauge views of all sections of society
- To distribute resources evenly
- To allow same personal freedom for men and women
- To even out the gender bias present in the society

How to stop gender bias

- Education that helps create attitudinal shifts towards gender bias and activities to spread awareness.
- Continuous efforts towards breaking myths and stereotypes around gender.
- Ensuring State accountability to implement various schemes, policies, laws, constitutional guarantees and international commitments.
- Institutionalizing gender sensitive processes within various systems such as law and programmes.
- Encouraging community ownership in preventing violations based on gender discrimination.



Sexual harassment at workplace is an extension of violence in everyday life and severely affects. Women's right to work in a safe and secure environment. While it is the responsibility of every employer to ensure safety of women at the workplace, it is also important for the trainees, both men and women, to be aware of all aspects of sexual harassment at the workplace. Skill training for both male and female trainees and professionals in the skilling ecosystem is centered around the following issues:

- What constitutes workplace sexual harassment?
- Where can the aggrieved complain about the same?
- What are the rights of the aggrieved?
- What is the redressal mechanism?
- Which are the bodies involved in addressing these complaints?
- What are the possible actions that can be taken against the accused?

Resources



Scan the QR code or click the link to access the videos or e-book.

Description	QR Code
Health related threats in apparel industry and control on them	 https://youtu.be/POIQ27GQZp0
First aid	 https://youtu.be/DQ7JPNgU8Wg

Gender sensitization	
	https://youtu.be/Wi1exdO1lig



Industry Visit

The purpose of visiting an apparel manufacturing unit is to get hands on knowledge about various processes involved in the work of a Pressman. During the visit you have to interact with Pressmen and supervisors to understand how work is done in industry. Make sure that you keep a notebook handy and note down any important points that come up during your interaction at the apparel manufacturing unit. When you go to an apparel manufacturing unit, you should:

- Know about the production system.
- Understand the machine safety and maintenance rules of industry.
- Analyze how Pressmen:
 - » Use and maintain personal protective equipment as per protocol.
 - » Maintain a healthy lifestyle and guard against dependency on intoxicants.
 - » Follow environment management system related procedures.
 - » Identify and correct (if possible) malfunctions in machinery and equipment.
 - » Store materials and equipment in line with manufacturer's and organizational requirements.
 - » Minimize health and safety risks to self and others due to own actions.
 - » Monitor the workplace and work processes for potential risks and threats.
 - » Carryout periodic walk-through to keep work area free from hazards and obstructions, if assigned.
 - » Report hazards and potential risks/threats to supervisors or other authorized personnel.
 - » Participate in mock drills/ evacuation procedures organized at the workplace.
 - » Take action based on instructions in the event of fire.
- Ask questions to Pressmen/supervisors if you have any query.

Exercise

1. Heart rate of a healthy person should be:
 - a) 40-60 beats per minute
 - b) 70-110 beats per minute
 - c) 80-100 beats per minute
 - d) 60-100 beats per minute
1. What is not in Four A's of First Aid:
 - a) Awareness
 - b) Assessment
 - c) Action
 - d) Attitude
2. The symptoms of fracture:
 - a) Pain
 - b) Swelling
 - c) Visible bone
 - d) All of the above
3. Which degree of burn is explained as; Extremely Serious and requires many years with repeated plastic surgery and skin grafting to heal?
 - a) 1st Degree Burn
 - b) 2st Degree Burn
 - c) 3st Degree Burn
 - d) 4st Degree Burn
4. is a level of medical care which is used for victims of life-threatening illnesses or injuries until they can be given full medical care at a hospital.
 - a) Basic life support (BLS)
 - b) CPR
 - c) ABC
 - d) All of the above

6. Comply with Industry, Regulatory and Organizational Requirements and Greening of Job Roles



Unit 6.1: Comply with industry, regulatory and organizational requirements and Greening of Job roles



Key Learning Outcomes

At the end of this module, participants will be able to:

1. Carryout work functions in accordance with legislation and regulations, organizational guidelines and procedures.
2. Seek and obtain clarifications on policies and procedures, from your supervisor or other authorized personnel.
3. Apply and follow these policies and procedures within your work practices.
4. Provide support to your supervisor and team members in enforcing these considerations.
5. Identify and report any possible deviation to these requirements.
6. Explain the effect and importance of Greening of Job roles.

UNIT 6.1: Comply with Industry, Regulatory and Organizational Requirements

Unit Objectives

At the end of this unit, participants will be able to:

1. Carry out work functions in accordance with legislation and regulations, organizational guidelines and procedures.
2. Seek and obtain clarifications on policies and procedures, from your supervisor or other authorized personnel.
3. Apply and follow these policies and procedures within your work practices.
4. Provide support to your supervisor and team members in enforcing these considerations.
5. Identify and report any possible deviation to these requirements.
6. Explain the effect and importance of Greening of Job roles.

6.1.1 Defining Compliance for Your Organization

According to Merriam Webster the dictionary definition of compliance is as follows:

1. The act or process of complying to a desire, demand, proposal, or regimen, or to coercion.
2. Conformity in fulfilling official requirements.
3. A disposition to yield to others.
4. The ability of an object to yield elastically when a force is applied.



Fig.6.1.1: Regulatory Compliance

Supervisory compliance for industries, world- wide falls under the second definition. There are many managers, general councils, and policy officers that would consent in agreement at any of the other definitions as well. Let's discuss, what is compliance? Whether an organization is confronting an external regulatory compliance from a government agency, or seeks to comply with its own organizational mandates, policies or procedures, compliance in actuality means conforming to requirements and a proof that your organization has done so. This is usually attained by the scheming and development of managerial policies that will map out the projected code of conduct.

From a policy's point of view, there are many aspects that impact an organization's policies, including legislative and regulatory requirements, organizational best practices, and the market demands. If we look at government/ public sector agencies, financial service businesses, and healthcare providers - we find that they are controlled and must develop internal policies in order to ensure compliance. The actual trial comes from the juncture of practice with the laid policy.

After that, they must adopt ways to enforce those policies and measure their effectiveness. Initially this may seem to be an easy and convenient task. But the dilemma is creating a policy – without any mechanism, may it be manual, automated, or third-part, to measure and monitor compliance of the policies is very difficult. In order to build effective policies, we must not only have an understanding of the statutory requirements that will shape

the policy within our organizations, but how these policies relate to the business practices, the workforce, the methodologies of operations and the technologies within the corporation.

Irrespective of the requirements to which an organization must obey, a well-planned model is essential which will be one that assimilates strategies with their people, processes, and technology. This includes education, monitoring, and enforcement. Organizations should look to use machineries and to develop procedures that make it easier to do the right thing or to simply disregard the policy all together. In conducting performance audits, an assessment should be made of compliance with applicable laws and regulations when necessary to satisfy the audit objectives. The auditor should design the audit to provide reasonable assurance of detecting illegal acts that could significantly affect audit objectives. The auditor also should be alert to situations or transactions that could be indicative of illegal acts that may have an indirect effect on the audit results.

6.1.2 Significance of Compliance in Indian Garment Industry

Compliance is the standard for the product which ensures that it is aligned to its industry's qualitative demands. This also includes audits and inspections which are crucial to a proper and formal work environment. Compliance and its demand is rapidly growing in today's industrial scene since globalization of manufacturing standards has also created a demand for ethically created products. This standard of compliance is crucial because of the increase in export of garments from India.

Social Compliance

The treatment of the employees by its business constitutes social compliance. This also includes their environment and their personal perspective on social responsibility as an employee. The treatment of employees regarding wages, work conditions and working hours. A compliance audit is necessary in order to determine if the company meets standard environmental laws.

Compliance Audit

Process Safety Management, Risk Management Programs, and Process Security Management are all organised and provided by audits and assessments. Compliance and its verification is carried out with audits that focus particularly on these policies and procedures. The design and implementation of these audits ensures this compliance. Additionally, all sorts of deficiencies can be addressed and solved through corrective action.

In India, compliance audit consists of a thorough examination of orders, regulations, rules and directions for dealing with prudence, legality, transparency and adequacy. It is the job of auditors to collect information by reviewing documents, visually observing the site and staff interviews. This data is cross checked with applicable regulations and permits to ensure how well the operation is when sieved through applicable and required legalities.

There are three main phases of compliance audit in India:

1. **Pre-audit:** It includes planning and organising the audit; establishing the audit objectives, scope and etiquette; and reviewing the design of the program by inspecting documentation
2. **On-site audit:** It includes conducting personnel interviews, reviewing records, and making observations to assess program implementation
3. **Post-audit:** It includes briefing the management on audit findings, and preparing a final report

Therefore, Indian apparel manufacturers need to follow Government guidelines, and social compliance standards not only within their sphere of operations, but also insist their vendors, distributors, and other collaborators involved in the supply chain to do the same.

6.1.2.1 Core Labour Standards

International labour standards have grown into a wide-ranging system of gadgets on work and social policy, backed by a administrative system intended to address all sorts of complications in their submission at the national level

- Removal of Discernment in Employment and Occupation
- Freedom of Association
- Right to Collective Bargaining
- Elimination of all Forms of Forced or Compulsory Labour
- Effective Abolition of Child Labour

Apparel industry players would ensure that labour contractors don't involve forced labour or child labour and get the supply chain of the suppliers audited. Apparel Export Promotion Council (AEPC), a top organization of Indian apparel exporters, has envisioned a garment factory compliance program 'Disha' -Driving Industry towards Sustainable Human Capital Advancement. The prime objective of this body is to make India a global benchmark for social compliance in apparel Industrial. This Common Compliance Code design will prepare the Indian apparel industry on a mutual platform towards a more social and ecologically compliant industrial atmosphere.

6.1.3 India Adopting Universal Standards on Child Labour

The compliance level of garment factory is very high for Indian exporters. To ensure that all standards are being complied with, the big international companies, mindful of their branding, often generate and follow their own compliance standards. Numerous U.S. companies have incorporated "child labour" in their code of conduct, due to tenacious signal of child exploitation in the industry.

6.1.3.1 Common Compliance Code

There is a compliance exhaustion in the Apparel Industry,. Although they are trading with the global brands, the apparel sellers still don't consent that compliance is an integral management practice. The Indian apparel export industry has been indisputable to implement zero tolerance on child labour and cleanse the supply chain.

"This common compliance code will not only give the opportunity for the industry to negate international claims against child labour promotion in the garment industry, but will also help to improve the image of the industry and win more international businesses," as per PremalUdani, Chairman, Apparel Export Promotion Council (AEPC).

6.1.4 Role of AEPC in Indian Garment Industry

The apparel industry of India is one of the significant export segments. It enjoys a good global ranking because of its quality and price affordability. But there is an emerging need to increase effectiveness in the social domain as the industry faces various labour, compliance and background situations.

Being a labour rigorous industry, social compliance is becoming an integral issue for this sector. The apparel export promotion council of India (AEPC) under the textiles ministry is plateful domestic textile trade to follow the global norms through development and application of tools to help workshops certify, monitor and improve universal standards.



Fig.6.1.2: AEPC Logo

AEPC's assistance to garment exporters

AEPC brings about invaluable backing to Indian garment exporters and also the international buyers who select India as their favoured trading terminus for garments. The body today has grown-up to become the most powerful connotation for promotion and facilitation of garment exports. With an objective of structuring a strong ground for Indian exporters, AEPC is devoted to provide various podiums which would help in increasing garment exports.

Role of Apparel Export Promotion Council in India

In India, the Apparel Export Promotion Council (AEPC) is committed to legal compliance and principled business Practices. It encourages members/exporters to comply with all applicable laws and regulations of the country to meet international compliance standards. Further, the council has designed a garment factory compliance program 'Disha' (Driving Industry towards Sustainable Human Capital Advancement) that aims to spread awareness regarding the importance of compliance among garment exporters.

6.1.5 Indian Garment Industry and Social Responsibility

The apparel industry of India, is one of the biggest segments among the various industries existing. It is also one of the oldest and an eminent industry in terms of output, investment and employment. A sector which has a global market share and has earned reputation for its permanence, worth and magnificence. The industry is growing at a fast pace with change in customer taste and inclinations. There are numerous factors impacting a change in customer preferences. Few of them are here:

- Rise in disposable incomes
- Government policy focused on fast-track growth
- Convenience of shopping at departmental stores and shopping malls
- Increasing demand for branded apparels and fashion accessories
- Boom in the retail industry

6.1.5.1 International Labour Standards

The Indian apparel industry had established itself substantially not just in the domestic but global market too. The improved density from international apparel buyers to comply with labour principles and rights in Indian garment factories has resulted into a vast number of labels and code of conduct.

6.1.5.2 Corporate Social Responsibility

Corporate social responsibility (CSR) fundamentally connotes that the establishment should work in a principled way. It should work in the best interest of the parties associated with it. The notion of social accountability and responsibilities in Indian apparel sector is fastening acceptance. Increasing number of companies are tiresome to work in a mode to defend the interests of the workforce, clients, contractors and the society.

6.1.5.3 Social Responsibility in the Garment Industry

Garment firms have social responsibility associated with workforce and the surroundings. Social responsibility in the global clothing industry gives a deep examination of labour practices and values. But the ways by which the various organisations take up to accomplish their social accountability may be different. A garment factory can fulfil its social responsibility in the following manner:

- By creating and providing a challenging environment to the workforce.
- Creation and provision of fair book of policies for any kind of employee dispute, if any.
- Affirm a safe and positive working environment for the employees.
- Prohibit child labour and abolish any kind of child abuse.
- Provision of equal opportunities to the employees to voice their feedback and have an effective policy for the solution of dispute.
- Ensure ethical recruitment, training, remuneration, appraisal and other policies.

6.1.6 Indian Apparel Trade and Compliance Standards

With the increasing globalisation, a lot of prominence has been placed on global compliance standards in the garment industry. Factories involved in the international trade must keep a proper check of the garment factory compliance at regular interludes. Therefore, every apparel export business needs to have a proper understanding of compliance rules for foreign trade.

6.1.6.1 Why Code of Ethics is Required

The code of ethics is concerned with the quality of the products and services from the workstations along with the working environment that should meet the provisions of audits and assessments. If followed sincerely, these ethics will result into:

- Cumulative national affordability in terms of social compliance.
- Growing competitiveness of small scale industrialists.
- Dropping burden on manufacturers.

Some of the compliance codes in Indian garment industry are listed below.

6.1.6.2 Working Hour & Wage Rate Compliance

- Garment workshops should ensure a confirmation that employees should get minimum wages as per the domestic law and according to their working hours spent by them in the industry.
- Employer should confirm an equal wages to both men and women employees who are performing the same work or work of a similar nature.
- Workforce employed for more than nine hours on any day or for more than 48 hours in any week, shall be qualified to wages at premium legal rates for such overtime work.
- Every employee must be entitled to one holiday in a week. Whenever a worker is required to work on a weekly holiday, he is to be allowed a compensatory holiday for each holiday so lost.

6.1.6.3 Workplace & Work Environment Compliance

- Businesses units should see that they are providing a proper clean, hygienic, well-ventilation, sufficient light and air to provide the workforce with standard work environment. A comfortable workstation with a clean and neat workplace is a mandate.
- Indian garment industries should ensure that the workers are given a comfortable sitting chair with back support and proper leg space.

6.1.6.4 Non-discrimination Compliance

Under federal and state laws, it is in contradiction of the law for proprietors to differentiate staffs and job applicants and/or harassment to occur with their organizations. It is also against the law to treat people unethically or bother them because of the age, disability, homosexuality, marital or domestic status, race, sex or transgender status of any relative, friend or colleague of a job applicant or employee. Employers, managers and supervisors must treat all their job applicants and employees on the basis of their individual merit and not because of irrelevant personal characteristics. They must also do their best to make sure that their employees are not harassing any other job applicant or employee.

6.1.6.5 Social Compliance in India

Religion, community, culture or belief characteristics should never be the basis of distinction among employees by the organisation. All the terms and conditions of employment should be based on a person's ability to do the job. The mandate for social compliance is growing every day. One can accomplish a dynamic and vigorous compliance system only when the workforce is provided with an equal stand to voice their concern and have consultative instrument at the workplace.

The Apparel Export Promotion Council of India (AEPC), a summit framework of Indian apparel exporters, runs all social compliance services to meet international global standards. This council trains and monitors industrial unit to upgrade the factory conditions and labour values and standards.

6.1.7 Health and Safety Compliance in Indian Garment Industry

Apparel industry has won increased attention from consumers, social workers, welfare organisations and trademarked international buyers. Many global players are demanding that their "code of conduct" should be complied to, before entering into an agreement. Nowadays, continuous observance to quality standards and employee contentment have become significant bounds for gauging the company's performance.

Apart from the growing quality of outputs that meet transnationally recognised standards, it is essential for the suppliers to improve safety and health compliance code and provide proper working atmosphere in their work locations.

Numerous overseas countries have established various international compliance standards on safety and health compliance. Exporters should follow these codes to live on in the global market. One should not under-estimate the benefits drawn from regular drilling of compliance codes of conduct which can bring higher price of yields, less employee turnover rate, smooth trade relation as well as global image & status.

6.1.7.1 Need for Compliance Codes

There is prominent impact of social compliance on company's economic outcomes. Companies should adopt compliance code to protect their goodwill and brand name in the market. The Indian apparel industry needs to be hard-hitting on compliance rather than opposing with other developing countries manufacturing low-cost garments.

6.1.7.2 Compliance Code Guidelines

Apparel factories ought to contemplate the below mentioned guidelines when complying with safety and health compliance code standards:

- Trades should comply with international standard code, such as ISO or importing countries standard code to become competitive in international markets.
- It is necessary for workers involved in loading and unloading operations.
- Young adults (between 15 to 18 years) are not allowed to work on any dangerous machine without sufficient training and supervision.
- Ear plugs or muffs should be given in places with excessive sound such as generator rooms and embroidery rooms.
- Factories should have effective fire extinguisher with proper usage instructions.
- Eye-wear and face shields should be a must, providing in areas with danger of flying objects, sparks, glare, hazardous liquids and excessive dust.

Code to protect their goodwill in the market

This industry needs to be tough on compliance rather than challenging with other developing countries manufacturing inexpensive garments. In India, the Apparel Export Promotion Council (AEPC) is committed to legal compliance and ethical business practices and encourages members/exporters to comply with all applicable laws and regulations of the country to meet international compliance standards.

The council has designed a garment factory compliance program 'Disha' (Driving Industry towards Sustainable Human Capital Advancement) that aims to spread awareness regarding the importance of compliance among apparel exporters.

6.1.8 Compliance Code Guidelines for Indian Garment Industry

The Indian apparel industry supports considerably to India's export earnings. India has industrialised as a major following destination for various buyers. The USA and the EU endure to be the most domineering markets for Indian apparel industry, bookkeeping for about two-third of India's textiles exports. These countries have been demanding upon compliance to certain social, environmental and safety standards and norms by the manufacture units involved in export business. Corporate codes of conduct that discourages labour standards vary from corporation to corporation and location to location. Some of the common Indian Garment industry compliance code guidelines are:

- Exporters must not be intricate in unfair labour practices but limited to interferences in matters regarding freedom of association.
- Exporters shall recompense workforce for all hours operated. Workers on a piece rate payment scheme or any other incentive scheme should be paid according to that.

- Exporters shall not illogically restrain the liberty of movement of workers, including movement in canteen during breaks, using toilets, accessing water, or to access necessary medical attention, as a means to maintain work discipline.
- Exporters are about to offer workers with paid annual leaves as required under local laws, guidelines and processes. Exporters shall not impose any undue limitations on workers' use of annual leave or taking any type of sick or maternity leave.
- There shall be no alterations in workers remuneration for work of equal value on the basis of gender, race, religion, age, nationality, sexual orientation, social political opinion, disability or ethnic origin.
- Exporters shall not threaten female workers with firing or any other employment conclusion that adversely distresses their service status in order to avert them from getting married or becoming pregnant.
- Exporters shall confirm that proper ventilation systems are installed within their premises to prevent airborne exposures which may affect the health of workers.
- Members shall not custom any form of physical or mental, emotional violence, threats, harassment, or abuse against workers seeking to form organisations or participating in union activities, including strikes.
- Workers shall be permitted to at least 24 successive hours of rest in every seven-day period. If workers must work on a rest day, another successive 24 hours rest day must be provided.
- Exporters shall pay workers at least the legal minimum wage or the usual industry wage, the one that is Higher. This indeed is the most essential code of compliance for Indian Industry.
- Garment exporters must ensure that the minimum age requirement to unsafe employment shall not be less than 14 years. This is the most significant concern in the country. Each worker has the right to enter into and to terminate their employment freely. Indian apparel makers need to follow all the compliance rules to comply with global standards. Often companies adopt industry compliance codes to project a positive image and protect their goodwill in the market. The Indian garment industry needs to be strong on compliance instead of competing with other developing countries manufacturing inexpensive garments.

Indian apparel makers need to follow all the compliance rules to comply with global standards. Often companies adopt industry compliance codes to project a positive image and protect their goodwill in the market. The Indian garment industry needs to be strong on compliance instead of competing with other developing countries manufacturing inexpensive garments.

6.1.9 India Complying with International Standards on Child Labour

Child labour has been a grave crime in India. It still exists. Children are in poverty, ignorance, and corruption due to illiteracy. Child labour superfluties under many conditions such as discernment (based on gender, ethnic, or religious issues), inaccessibility of educational and other substitutes, weak enforcement of child labour laws, etc. Large global firms, conscious of their image, often set up their own compliance standards for the exporters to ensure that all standards are being complied with.

Various companies of U.S originality have included child labour in their code of conduct, due to tenacious evidence of child exploitation in the industry. In worldwide market, the buyer's compulsory requirement is to have an audit. As India is a leading garment exporter, the level of garment factory compliance is very high for Indian exporters. The child labour issue is one of the very important aspect that the audit checks. Therefore, all the export units must be highly compliant on issues related to child labour.

6.1.9.1 Code of Conduct for Garment Exporters

- Garment exporters must safeguard that the bottom limit of the age requirement to non-hazardous employment should not be less than 14 years. Moreover, all young workers (between 14 to 18 years) must be sheltered from doing any work that is likely to be dangerous or that may be injurious to their health and physical, mental, social, or moral development. Exporters must detect all legal necessities for work being performed by lawful young workers.
- Further, the trainees or occupational students shall not be under the legal age for employment (as provided under the applicable laws). They cannot be used on regular production lines as long as they are trainees and unless their pay and other benefits are at par with the regular workforce.
- A proper process is followed for checking the age of the workers. The minimum certification and credentials required to be maintained shall include- proof of age certificates by registered/ licensed dentists, birth certificate, school leaving certificate, national identity like passport, driving license, voter card etc. or any other document required under the applicable laws.

Apparel industry players would now make sure that labour contractors don't engage child labour and get the supply chain of the suppliers audited. Apparel Export Promotion Council (AEPC) has intended a garment factory compliance program 'Disha' (Driving Industry towards Sustainable Human Capital Advancement) to make India a global benchmark for social acquiescence in apparel manufacturing and export. This Common Compliance Code project will prepare the Indian apparel industry on a mutual platform towards a more social and environmentally accommodating industrial environment.

6.1.10 Green Jobs

"Green jobs' are defined as jobs that reduce the environmental impact of enterprises and economic sectors, ultimately to levels that are sustainable."

Green jobs can produce goods or provide services that reduce environmental impact, such as green buildings or clean technology adoption. An important section of green jobs lies in sustainable or clean manufacturing. India has already begun preparation towards a green transition by institutionalizing capacity buildings for green jobs through jobs, including legal regulations and skill mapping. The country is accelerating the expansion of green jobs in large industries like automotive, textile, brick manufacturing, power sector, and green buildings. It is gradually expanding its coverage to hard-to-abate sectors such as steel, thermal power plants, and manufacturing SMEs.

India will soon be the most populous country in the world – and home to one of the youngest populations. India is the world's third-largest energy consuming country, with 80 per cent of demand met by coal, oil and solid biomass. Despite its efforts, India is predicted to be among the top three emitters by 2030. Millions of Indian households are set to buy new appliances, air conditioning units and vehicles.

Rapid growth is expected in building stock, other infrastructure, and construction materials. In recent years, India created a massive expansion in renewable energy. India's efforts at promoting LED lighting are a huge success story. Over 367 million LED bulbs, 7.2 million LED tube lights and 2.3 million energy efficient fans have been distributed. This has brought big savings in power use, greenhouse gas emissions and household bills.

India has also taken steps to control plastic pollution, including bans on single-use plastic and strengthening extended producer responsibility. India has also committed to restoring 26 million hectares of degraded land by 2030. But India, like every nation, must do more. And doing more is in the best interests of the entire nation. A recent World Economic Forum estimate suggests that India's decarbonization journey represents a USD 15 trillion economic opportunity by 2070. This journey could create as many as 50 million net new jobs.



Fig. 6.1.3: Diversified green jobs

About sustainability and sustainable workplace

Sustainability, greening the corporation, environment management are gradually becoming a part of the corporate vocabulary. The way the natural resources are extracted and consumed from earth, it is going to be very difficult to replenish them timely. It is often discussed in various forums that for generating the resources we spend in one year; earth takes around 1.5 years for the re-generation. Hence, it can be assumed that there will a requirement of the capacity of almost two Earths by 2030 to keep pace with the present natural resource consumption, and the requirement will be of three planets by 2050.

The current requirement is towards developing long-term, meaningful relationships, and self-discipline for attaining effective results. Thus, the design of the workplace is such that supports the basic and core idea in a more accommodating and comprehensive manner.

A Green workplace is an eco-friendly and focused organisation and leans towards the adoption of business practices that are justifiable in nature, energy efficient, and well suited to the complex as well as the ever changing world of business. It advocates the model based on 3Rs — reduce, reuse, recycle. It encompasses green competencies, green attitude, and green behaviour, which is combined synergistically to help the organisation become green or sustainable. Values are the essential characteristic that both employees and organisations uphold and operate at multiple levels (societal, organisational and personal), thus playing a fundamental role in shaping the organisation's culture with regard to a shift towards greater sustainability.

The idea of introducing green initiatives into the workplace can feel a little daunting at first. And while it may feel overwhelming trying to figure out where to start, there are actually lots of ways we can be more green in the office without bringing the whole forest inside, without huge cost implications and with long-term benefits to the company, employee well-being and future spend. Implementing a few simple changes for a more sustainable, green workplace can be really effective in reducing your business' impact on the environment.

Sustainability is now counted as one of the major pillars of apparel export business and a growth tool. Though its key areas involve saving of energy, water, more greenery in the factories, maximum use of natural resources, green factories, there are many other initiatives which are being taken by various companies as per their need, priorities, and with the changing sustainability landscape, bench marks and issues are also evolving. All these efforts are generating great results, bringing buyers closer to them and creating a sense of profitability and responsibility amongst the companies towards the people and the planet.

A Few Green workplace initiatives

1. Discourage food and water wastage
2. Switch off the lights or power when not in use
3. Switch off the sewing machine when not in use
4. Stop using Single use Plastic
5. Segregate waste as per waste management/disposal policy
6. Any sort of wastages like empty glasses/bottles/plastics/containers etc should be kept in a specific area to be recycled
7. Throw waste only in the allocated basket or trolley
8. Minimise use of paper
9. Use of LED lights
10. Installation of solar panels

Encourage similar practice at home also.



7. Soft Skills

- Unit 7.1 - Introduction to the Soft Skills
- Unit 7.2 - Effective Communication
- Unit 7.3 - Grooming and Hygiene
- Unit 7.4 - Development of Interpersonal Skill
- Unit 7.5 - Social Interaction
- Unit 7.6 - Group Interaction
- Unit 7.7 - Time Management
- Unit 7.8 - Resume Preparation
- Unit 7.9 - Interview Preparation



Key Learning Outcomes

At the end of this module, participants will be able to:

1. Interpret the basic meaning of Soft Skills, their components and their benefits.
2. Interpret Work Readiness and its significance.
3. Explain communication process.
4. Explain about verbal and non- verbal communication.
5. Explain about the barriers in communication process.
6. Maintain cleanliness and hygiene.
7. Identify specific uniform guidelines
8. Maintain positive body language while speaking.
9. Interpret good eating habit and their impact on health.
10. Develop a positive attitude and behavior.
11. Explain team dynamics.
12. Explain how to manage relations.
13. Learn about Stress and anger management skills.
14. Learn to develop leadership qualities.
15. Explain about what is social interaction and what are social interaction behaviors.
16. Practice Self introduction in public.
17. Participate in group discussions in the class.
18. Identify the importance of team building and team work.
19. Explain about the time management.
20. Develop time management skills.
21. Learn about effective time planning.
22. Interpret the importance of resume.
23. Learn how to prepare a resume.
24. Explain the procedure of interview.
25. Practice mock interview.
26. Identify how to present themselves during an interview.

UNIT 7.1: Introduction to the Soft Skills

Unit Objectives

At the end of this unit, participants will be able to:

1. Interpret basic meaning of Soft Skills, their components and their benefits.
2. Explain the components and their benefits.

7.1.1 What is a Soft Skill?

Soft skills are personal attributes that describes an individual's ability to interact with others. Soft skills is a term often associated with a person's EQ, the cluster of personality traits, social graces, communication language, personal habits, friendliness and optimism that characterise relationship with other people. Soft Skills complement hard skills which are occupational requirements of a job and many other activities. They are related to feelings, emotions, insights and an inner knowing.

Soft skills have more to do with who we are than what we know. As such soft, skills encompasses, the character traits that decide how well one interact with others and are usually a definite part of one's personality.

According to a survey the long term success in job is 75 % due to soft skills and 25 % due to technical knowhow. Soft skills also determine how satisfied and happy one remains in professional and personal situations.



Fig.7.1.1: Soft skills

7.1.2 Components of Soft Skills

- Adaptability
- Emotional Strength
- Leadership Quality
- Team Playing Ability
- Decision Making
- Interpersonal Communication
- Negotiation Skills

7.1.3 Benefits of Soft Skills

Some of the benefits of Soft Skills are as:

- Increased credibility with customers.
- Increased customer satisfaction.
- More productive employees.
- Out service the competition.
- Recognition from the industry, employer and peers.
- New employment opportunities.
- Increased ability to perform on the job.

UNIT 7.2: Effective Communication

Unit Objectives

At the end of this unit, participants will be able to:

1. Explain the meaning of Communication and process of communication.
2. Elaborate about the types of communication.
3. Identify the barrier in effective communication.

7.2.1 Introduction

In the information age we have to send, receive and process huge number of messages everyday. But effective communication is more than just exchanging information, it also about understanding the emotion behind the information. Effective communication can improve relationship at home, work, and in social situations by deepening our connections to others and improving teamwork, decision making and problem solving.

Effective communication skill is a learned skill, it is more effective when it's spontaneous than formula.

7.2.2 The Communication Process

The process of conveying information through the exchange of thoughts, ideas, feelings, intentions, attitude by speech, gesture, writing etc. is known as communication. It is the meaningful exchange of information between two or more participants.

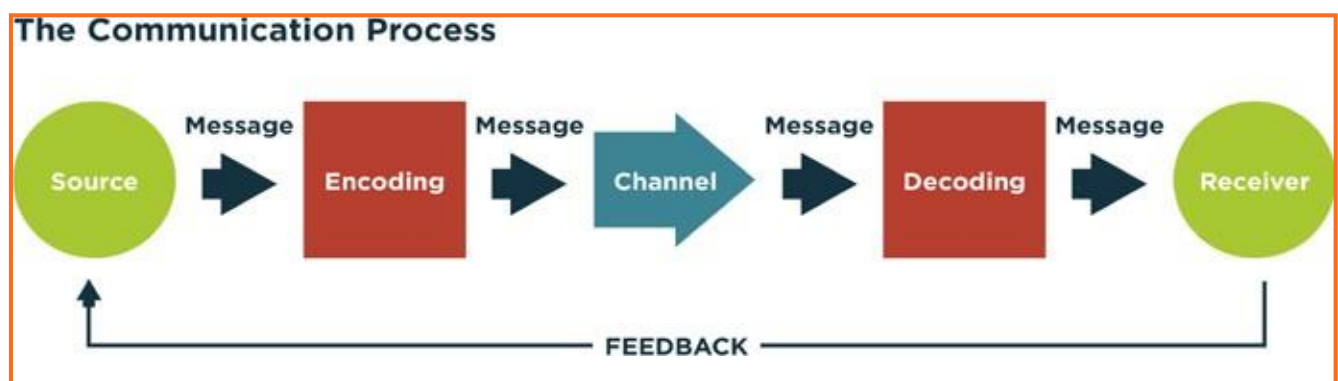

Fig.7.2.1: The Communication Process

Communication requires a sender, a message, a medium and a recipient. Communication process is complete only when a receiver understands the sender message.

Communication with other involves three steps:

1. **Message:** First information exists in the mind of the sender. It can be a concept, idea, formation and feeling.
2. **Encoding:** A message is sent to the receiver in words or other symbols.
3. **Decoding:** Lastly the receiver translates the words or symbols into a concept or information that a person can understand.

7.2.3 Verbal and Non-Verbal Communication

Communication can be categorized into three basic types. These include:

1. **Verbal Communication:** It means you listen to a person to understand their meaning. Verbal communications have the advantage of immediate feedback, are best for conveying emotions and can involve storytelling and crucial conversations.
2. **Written Communication:** letters, books, newspapers are printed messages in which you read their meaning. They are asynchronous, can reach many readers and are best for conveying information.
3. **Nonverbal Communication:** It means you observe a person and infer meaning. Both verbal and written communications convey nonverbal communication and are also supported by body language, eye contact, facial expression, posture, touch and space.

7.2.4 Communicating Effectively Identifying Barriers

There are many reasons why communications fail. These failures are the result of barriers in communication which may occur at any stage in the communication process. Barriers may lead to one's message becoming distorted and therefore risk wasting both time and money by causing confusion and misunderstanding. Effective communication involves overcoming these barriers and conveying a clear and concise message.



Fig.7.2.2: Barriers in Communication

A skilled communicator must be aware of these barriers and try to reduce their impact by continually checking understanding or by offering proper feedback.

Dealing with Barriers

- Use simple, easily understood word. Overcomplicating makes things confusing
- While speaking in other language always prepare beforehand
- Always give or take feedback to ensure the effectiveness of communication
- Be alert to cues
- Listen, listen, listen ...

7.2.5.1 Some Tips for Active Listening

- Concentrate what the person is talking about and not on noise or other external distractions.
- Understand his emotions and you get it all right. Is the speaker angry, happy or plainly inquisitive?
- When the speaker is saying or telling something, don't break the chain of his thoughts.
- Don't avoid completing sentences of the speaker. Let them speak and speak only after they finish.
- It's alright if you haven't understood at first chance. Request to repeat the information.
- Practice makes a man perfect. Listen intently, focus and ignore other noises. Listen more and talk when required.

It takes a lot of concentration and determination to be active listener. Old habits are hard to break and if you're listening habits are not good then you have to break those. Start listening deliberately and remind yourself frequently that your goal is to hear truly what the other person is saying.

UNIT 7.3: Grooming and Hygiene

Unit Objectives

At the end of this unit, participants will be able to:

1. Maintain cleanliness and hygiene.
2. Keep their dress clean and tidy.
3. Maintain positive body language while speaking.
4. Enable to perform more of the do's than the don'ts.
5. Avoiding bad things such as gutkha and alcohol.

7.3.1 Personal Grooming

Personal Grooming is the term for how people take care of their body appearance. Once you enter your store/ department you need to be dressed in full uniform as per company norms, and also properly groom yourself as per the service standards.

Personal grooming not only makes us presentable to other people but good personal hygiene is essential for good health. Habits that are considered personal grooming include, bathing, dressing, applying makeup, hair removal and taking care of one's teeth and skin.

7.3.2 Positive Body Posture and Language

- Clean hands at all times as they mostly will be handling merchandise and customers.
- Avoid biting nails on the floor.
- Manage body odour & bad breath to be under control as they are offensive to the customer.
- Maintain straight & upright posture on the shop floor.
- Slouching on the floor, hands in pockets, hands on the hips are not courteous to the customer.
- Keep your hands out of your pocket
- Don't Fidget. Fidgeting is a clear sign of nervousness
- Keep your eyes forward. This indicates that you are interested in communication with other.
- Stand up straight with your shoulders back. It communicates confidence.
- Don't cross your arms when meeting other persons.

7.3.3 Personal Hygiene

Personal Hygiene is the set of practices to follow to preserve one's health. Maintaining a high level of personal hygiene will help to increase self-esteem while minimizing the chances of developing infections. Poor personal hygiene can have significant implications on the success of job applications or chances of the promotion.

7.3.4 Physical Fitness

Apart from following these hygienic practices, one should also be physically fit. Physical fitness is an outcome of regular exercise. Exercise may be of many different forms. Jogging, morning-walk, weight-lifting, gym, swimming, cycling, yoga and many more.

Things to be avoided

There are certain habits that have severe ill-effects on one's health. Such habits should be avoided for a healthy life.

- Alcoholism
- Tobacco / Smoking
- Gutkha

UNIT 7.4: Development of Interpersonal Skill

Unit Objectives

At the end of this unit, participants will be able to:

1. Develop a positive attitude and behaviour.
2. Describe the goal setting.
3. Motivate for team participation at work.
4. Practice relations and stress management at work.
5. Develop leadership qualities.

7.4.1 Introduction

Interpersonal skill development is the blend of different traits of day to day life that play an important role in creating our impression in other's mind. It starts from inside. The role of interpersonal skill development is to help us understand how to make choices about our attitudes and actions.

These include various traits like:

- Positive Attitude
- Motivation
- Goal Setting
- Team Work
- Managing Relations
- Etiquette
- Stress and Anger Management
- Conflict Resolution

7.4.2 Goal Setting

Goal setting is a powerful process for thinking about your ideal future. The process of setting goals helps you to choose where you want to go in life.

Goal setting involves establishing specific, measurable, achievable, and realistic and time targeted goals. Goal setting helps people work towards their own objectives. Goals are a form of motivation that sets the standard for self-satisfaction with performance. Achieving the goal one has for oneself is a measure of success and being able to meet job challenges is a way one measures success in the workplace.

1. Financial
2. Education
3. Family
4. Health
5. Public Service

7.4.3 Team Dynamics

A team comprises a group of people associated for a common purpose. Teams are especially appropriate for conducting complex tasks. A team is a special instance of a group in which shared goal is the common thing. This creates a dynamic between team members and because they are dependent on each other for success. For example a sports team wins or loses as a whole.

Factors of Team Dynamics

- Tolerance and Cooperation
- Set aside feelings of caste, creed, profession
- Put up with each other
- Identify strengths of each
- Who can do what

7.4.4 Managing Relations

We all have different personalities, different wants and needs, and different ways of showing our emotions which affects people around us.

70% of the workplace learning is informal, when people talk to each other at work they actually are learning to do their job better. Friendlier workers are effective communicators, more productive and trusted more by employers and co-workers.

Stress and Anger Management

Anger is a normal and a healthy emotion. Managing anger can be a problem for some people who find it difficult to keep their anger under control. There are many health issues related to a unresolved anger such as high blood pressure, heart attack, depression, anxiety, colds and flu and problems related with digestion.

Always remember:

- Avoid unnecessary stress, learn to say no and take control of your environment.
- Express your feelings instead of boiling them up.
- Accept the things you can't change.
- Learn to forgive.
- Don't react immediately.
- Post pone for a few seconds whatever you wish to say or do.
- Take a deep breath.
- Speak when you have calmed down.

7.4.5 Etiquette

Etiquette are the customs or rules governing behaviour regarded as correct or acceptable in social and official life. It includes:

- Making Positive Impression
- How you treat with people
- Communicating at Workspace
- Work Ethics
- Discipline
- Commitment to work:
- Punctuality
- Ownership and responsibility
- Striving to excel:

7.4.6 Conflict Resolution

What is a Conflict?

A problem or a situation that may be difficult to understand or to deal with.

Why do we need to resolve conflicts?

- If a problem is not solved or addressed at the right time it may blow out of proportion
- An unsolved problem can be like Cancer which spreads and translates itself into all other areas in life
- Unsolved problems may lead to increased levels of bitterness and frustration
- It may foster bad habits like back-biting, gossiping, etc.
- Persons involved in conflict may lose focus and target each other's character instead of the specific behavior to be modified.

How to work out Conflicts?

- **STOP** - before you lose control of your temper and make the conflict worse.
- **SAY** - what you feel is the problem. What is causing the disagreement? What do you want?
- **LISTEN** - to the other person's ideas and feelings.
- **THINK** - of solutions that will satisfy both of you.

If you still can't agree, ask someone else to help you work it out.

7.4.7 Leadership Skills

The ability to lead effectively is based on a number of key skills. These skills are highly sought after by employers as they involve dealing with a number of people in such a way as to motivate, enthuse and build respect. Some of the qualities that every good leader should possess are:

- Honesty

- Ability to delegate
- Ability to take initiative
- Good communications skills
- Confidence
- Commitment
- Positive Attitude
- Creativity
- Be decisive
- Focus on the big picture

UNIT 7.5: Social Interaction

Unit Objectives

At the end of this unit, participants will be able to:

1. Analyze the social interaction.
2. Define duties and responsibility.
3. Explain about the team work.

7.5.1 Social Interaction

Social interaction is the process by which we act and react to those around us. It includes those acts people perform toward each other and responses they give in return. Social interaction includes a large number of behaviours. They are:

- Exchange
- Competition
- Cooperation
- Conflict
- Coercin

7.5.2 Self- Introduction

Everyone in their lifetime, have to introduce themselves to the audience or a class. It is a speech which lies around 3 minutes to 5 minutes. It is very important that it gives the first impression to other about us. It has a great impact on your self-esteem and self-confidence. It's helpful in:

- Feeling better about yourself
- Boosting your confidence
- Building your self esteem
- Making friends
- Feeling in control

Points for Self Introduction

- | | |
|-----------------|-------------------------------|
| • Wishes | • Location |
| • Purpose | • Hobbies/Habits |
| • Name | • Life Aim |
| • Father's Name | • Achievements |
| • Family | • Favourite Person's or Ideal |
| • Profession | • Your Strengths and Weakness |

7.5.3 Cooperation

Cooperation is the process of groups of organisms working or acting together for their mutual benefit. Cooperation among family members, friends and peers is very common and healthy. It is the backbone of any society.

Family cooperation provides an avenue for a family to come closer. It increases coping skills and decision making.

Experiential Knowledge: contributes to solving problems and improving quality of life.

- **Emotional support:** Esteem, attachment and reassurance
- **Instrumental Support:** Material goods and services.

How to be a cooperative person

For being a cooperative person following things needs to be done:

- Listen carefully to others and be sure you understand what they are saying.
- Share when you have something that others would like to have.
- Take Turns when there is something that nobody wants to do, or when more than one person wants to do the same thing.
- Compromise when you have a serious conflict.
- Do your part the very best that you possibly can. This will inspire others to do the same.
- Show appreciation to people for what they contribute.
- Encourage people to do their best.
- Make people needed. Working together is a lot more fun that way.
- Don't isolate or exclude anyone. Everybody has something valuable to offer, and nobody likes being left out.

UNIT 7.6: Group Interaction

Unit Objectives

At the end of this unit, participants will be able to:

1. Participate in group discussions in the class.
2. Give speech in the public.
3. Paraphrase the importance of team building and team work.

7.6.1 Group Interaction

Every day we meet with groups of people socially and professionally. How we interact plays a large role in the impressions we create. Interaction that occurs while a group completes a cooperative task describes how the group works.

Everything you do in a group setting makes an impression on everyone in the group. Don't ever think something doesn't matter. Everything matters. Take every opportunity to take part in informal and formal group interactions. Start by making small contributions to discussion, prepare a question to ask or agree with another person's remark. Ask for other persons opinion.

Dos and Don'ts of Group Interaction

Do's	Don't
<ul style="list-style-type: none"> • Speak pleasantly and politely to the group. • Respect the contribution of every speaker. • Remember that a discussion is not an argument. Learn to disagree politely. • Think about your contribution before you speak. How best can you answer the question/ contribute to the topic? • Try to stick to the discussion topic. Don't introduce irrelevant information. • Be aware of your body language when you are speaking. • Agree with and acknowledge what you find interesting. 	<ul style="list-style-type: none"> • Lose your temper. A discussion is not an argument. • Shout. Use a moderate tone and medium pitch. • Use too many gestures when you speak. Gestures like finger pointing and table thumping can appear aggressive. • Dominate the discussion. Confident speakers should allow quieter students a chance to contribute. • Draw too much on personal experience or anecdote. Although some tutors encourage students to reflect on their own experience, remember not to generalize too much. • Interrupt. Wait for a speaker to finish what they are saying before you speak.

Fig.7.6.1: Dos and Don'ts of Group Interaction

7.6.2 Teamwork

Teamwork is a very important part of working life. They can have a big impact on:

- The profitability of an organisation
- Whether people enjoy their work
- Staff retention rates
- Team and individual performance

Importance of Team Building

Team building activities not only boost morale of the team members, but it can also increase the success rate of the teams. Team building is an important activity as it:

- Facilitates better communication
- Motivates employees
- Promotes creativity
- Develops problem-solving skills
- Breaks the barrier

UNIT 7.7: Time Management

Unit Objectives

At the end of this unit, participants will be able to:

1. Describe the concept of time management.
2. Develop time management skills.
3. Explain effective time planning.

7.7.1 Time Management

Time management is the act of process of planning and exercising conscious control over the amount of time spent on specific activities, especially to increase effectiveness, efficiency or productivity. It is an activity with the goal to maximize the overall benefit of a set of activities within the boundary condition of a limited amount of time.

Some effective time management

- Delegate tasks.
- Identify time wasters.
- Combine activities – Plan for them.
- Break down big tasks down to the smallest task possible.
- Accomplish them one by one.
- At the end of the day conduct a simple analysis to see which activity took time.

7.7.2 Pareto Analysis

- According to this 80% of the tasks can be completed in 20% of the time. The remaining 20 % of the tasks take 80 % of your time. And the task which should fall in first category should be given a higher priority.
- Time also depends on the method adopted to complete the task. There are always simpler and easier ways to complete the task. If one uses complex ways then it will be time consuming. One should always try to find out alternate ways to complete a task.

Urgent Important Matrix

1. The Urgent and Important Tasks	2. The Non Urgent but Important Tasks
DO NOW <ul style="list-style-type: none"> • Emergencies, complaints and crisis issues • Demands from superiors • Planned tasks or project work now due • Meetings with superiors/colleagues 	PLAN TO DO THEM <ul style="list-style-type: none"> • Planning, preparation • Scheduling • Designing, testing • Thinking, creating, modelling the data

3. The Non Important but Urgent Tasks	4. The Non Important and non-Urgent Tasks
<p>REJECT AND EXPLAIN</p> <ul style="list-style-type: none"> • Trivial requests from others • Apparent emergencies • Misunderstandings appearing in work • Pointless routines or activities 	<p>RESIST AND CEASE</p> <ul style="list-style-type: none"> • Comfort' activities, computer • Games, net surfing, excessive • Cigarette breaks • Chat, gossip, social • Communications • Reading irrelevant and useless material

Fig.7.7.1: Urgent Important Matrix

This matrix helps you understand:

- What should be done
- What should be planned
- What should be resisted
- What should be rejected

The simplest method of managing time is to create a general to do list. Prioritize the task list:

- A daily list of things to do, numbered in the order of their priority
- Start with the most unpleasant and difficult task first latter will completed easily and quickly.
- Map out everything while making a task list
- Learn to say “No” to unimportant things
- Strikeout the things completed so that you are familiar what have been completed and what needs to be completed.

Prioritize the above mentioned activities in the following heads.

Important Tasks	Unimportant Tasks	Urgent Tasks	Not Urgent Tasks

UNIT 7.8: Resume Preparation

Unit Objectives

At the end of this unit, participants will be able to:

1. Explain the importance of resume.
2. Discuss basic steps for the preparation of a resume.

7.8.1 Introduction

A resume is a self-advertisement that, when done properly shows how your skills, experience and achievements match the requirement of the job you want. The resume is a tool with one specific purpose to win an interview. It convinces the employer that you have what it takes to be a successful in the new career or position.

It also establishes you as a professional person with high standards and excellent writing skills based on the fact your resume is written well. It also helps you clarify your direction, qualifications and strengths, boost your confidence or to start the process of committing to a job or a career change.

One must know about a resume that:

- Your resume is to get you an interview not a job
- Your resume will be screened by an employer for just 15-20 seconds. That's all the time your resume has to make an impact.

There are different sections on the resume in the same order as mentioned under:

Section	What is the employer looking for
Header	Your identity and to contact you
Objective	To check if their requirement and your objective match
Education	To check if you have the basic qualification for the job/ internship you are applying for
Practical Experience/Projects	To see if you have done anything that reflects your potential capability. Also to see how different you are from your peers.
Skills	How equipped you are in terms of your personality traits as well as occupational skills
Interests	Professional aspects apart, how meaningful is your life?
Other	Is there anything else significant and relevant you want to showcase, that will add value to your resume.

Fig.7.8.1: Different sections on the resume

7.8.2 Points to Remember

- Make sure that the length of your resume does not exceed 2 pages.
- Do a thorough recheck and make sure there are absolutely no errors in your resume. No grammatical errors, no spelling mistakes, no punctuation errors.
- Run through your resume time and again for to make improvements and wording sentences better.
- Choose a professional font in a size 11 or 12. You can use multiple fonts for different parts of resume, but try to limit it maximum of two fonts. Instead changing between fonts, try making specific sections bold or italicized instead.
- The font size of your header and the introduction to a section may be a size 14 or 16.
- Your text should always be printed in solid black ink. Make sure to deactivate any hyperlinks so that they don't print in blue or other contrasting colour.
- Your page should have one inch margin all the way around with 1.5 or 2 point line spacing. The body of your resume should align left and your header should be centred at the top of the page.

UNIT 7.9: Interview Preparation

Unit Objectives

At the end of this unit, participants will be able to:

1. Explain the procedure of an interview.
2. Prepare for interview.

7.9.1 Interview

An interview is a conversation between two or more people (the interviewer(s) and the interviewee) where questions are asked by the interviewer to obtain information from the interviewee. An interview is the first and last hurdle you need to cross in order to get a job.

Common Types of Interview

1. **Traditional HR Interview:** Most interviews are face to face. The most traditional is a one-on-one conversation with the HR Executive where the candidate's focus should be on the person asking question. You are advised to maintain good eye contact, listen keenly and answer promptly.
2. **Panel Interview:** In this situation, there is more than one interviewer. A panel ranging from two to ten members may conduct this part of the selection process. This is an ideal chance for you to display group management and group presentation skills.
3. **Technical interview:** The objective of this interview is to basically evaluate technical knowledge. Majority of the questions will be based on the skills sets mentioned in the candidate's resume.
4. **Telephone Interview:** Telephone interviews may also be used as a preliminary interview for candidates who live far away from the job site.

Before going for an interview, it is important to have clarity of the role you are applying for. It's also important that you know where you are applying and who will you be talking to. Your answers should tell the employer that you are the match they are looking for.

This requires you to do a small research on the following fields:

- Company & Field
- Job Description
- Yourself (Skills, Values & Interests)
- Resume (Experience)

It is important that you dress professionally. It is a proven fact that the way we dress makes a huge difference in the way we are perceived. 90% of the way you communicate with other people is through body language (gestures, expressions, etc.) and the first Impression we make. It is very simple to make a great first impression.

For a good first impression it is important those we:

- Smell good
- Have a professional appearance

- Pay attention to your grooming
- Make eye contact
- Know what and how you speak
- Our overall personality contributes to our complete perception.

How to dress for Interview

Men	Women
Long-sleeved buttoned shirt (clean and pressed)	Conservative pump, no stilettos
Dark shoes (cleaned and polished) and dark socks	Jewellery -One set of earrings (preferably knobs)
Get a haircut (short hair is always best)	No bangles
No Jewellery (chains, earrings, piercing)	Minimal use of makeup
No beards or Tattoos	

Fig.7.9.1: Dress for Interview

7.9.2 The Do's and Don'ts in an Interview

Some of you might have faced an interview and some of you might not have. However, by now, you definitely have a better understanding what are the accepted standards of a professional behaviour. Read the sentences given and mark them as do's or don'ts, in relation to an interview:

Sentence	Do's	Don'ts
Be yourself		
Burp while talking!!!		
Just out from a 'powder factory' (worn too much make-up)		
Reach just about the right time for the interview		
Just barge in the cabin/ office		
Forget to greet the receptionist/ don't respond		
Think before you speak		
Do your homework- Visit the company website		
Take time to think (TTTT)		
Wear bright colour clothes on the D-day		
Emphasis on your strengths		
Argue/ Debate with the interviewer		
Chew gum during the interview.		
Review your educational and work experiences		
See your documents flying out of the file (Being clumsy)		
Thank the interviewer		
Have the 'they need me' attitude		

8. Annexure-Resources



Module No.	Unit No.	Name of Subject	URL	QR Code
1. Introduction and Orientation	Unit 1.1 - Introduction to Sewing and Apparel Sector	Apparel Sector in India – Industry Overview	https://youtu.be/tN5oLGSjepQ	
1. Introduction and Orientation	Unit 1.2 - Role and Responsibilities of a Sewing Machine Operator	Role and Responsibilities of Sewing Machine Operator	https://youtu.be/aHo2Kp2LeiY	
2. Carry out Stitching Activities Using Machine or By Hand	Unit 2.1 - Prepare for Stitching Operations	Tools and equipment used in sewing	https://youtu.be/_2ZLtGfBJrY	
2. Carry out Stitching Activities Using Machine or By Hand	Unit 2.1 - Prepare for Stitching Operations	Types of Industrial Sewing Machines	https://youtu.be/_2ZLtGfBJrY	
2. Carry out Stitching Activities Using Machine or By Hand	Unit 2.1 - Prepare for Stitching Operations	Parts of a Sewing Machine	https://youtu.be/al_hc7DoKXk	
2. Carry out Stitching Activities Using Machine or By Hand	Unit 2.2 - Stitch Components to Produce Apparels	Different types of stitching and seam	https://youtu.be/NtmiZU1dkZM	
2. Carry out Stitching Activities Using Machine or By Hand	Unit 2.3 - Stitching a Trouser	Sewing a Trouser	https://youtu.be/Q3Y5Q_iW1Ao	

2. Carry out Stitching Activities Using Machine or By Hand	Unit 2.3 - Stitching a Trouser	Belt Loop Attaching	https://youtu.be/7Biev39gR2k	
2. Carry out Stitching Activities Using Machine or By Hand	Unit 2.4 - Stitching a Shirt	Stitch a shirt	https://youtu.be/g7AA-gfAKes	
3. Contribute to Achieve Product Quality In Stitching Operations	Unit 3.1 - Contribute to Achieve Product Quality in Stitching Operations	Classification of defects	https://youtu.be/SPtD6mAZ0GU	
4. Maintain Work-Area, Tools and Machines	Unit 4.1 - Maintain Work Area, Tools and Machines	Maintenance of single needle sewing machine	https://youtu.be/6iE2DT6LVpg	
5. Maintain health, Safety and Security in the Finishing Department with Gender & PwD Sensitization	Unit 5.1 – Maintain Health, Safety and Security at Work Place	Potential risks and threats associated with the workplace in garment industry	https://youtu.be/POIQ27GQZp0	
5. Maintain health, Safety and Security in the Finishing Department with Gender & PwD Sensitization	Unit 5.2 – First Aid & CPR	First Aid & CPR	https://youtu.be/DQ7JPNgU8Wg	
5. Maintain health, Safety and Security in the Finishing Department with Gender & PwD Sensitization	Unit 5.3 – Sensitivity towards People with disability and Gender Equality	What is sensitization	https://youtu.be/Wi1exdO1lig	



<https://youtu.be/aHo2Kp2LeiY>
Scan QR code to access e-book



Skill Council for Persons with Disability

Sector Skill Council Contact Details:

Address: 501, City Centre, Plot No. 5 Sector 12 Dwarka New Delhi - 110075

Website: www.scpwd.in

Phone: 01120892791

Price: ₹